

TECHNICAL MANUAL

No. 11-6625-1824-40P

HEADQUARTERS
DEPARTMENT OF THE ARMY
WASHINGTON, D.C., 2 March 1976

General Support Maintenance
Repair Parts and Special Tools Lists
Including Depot Maintenance Repair Parts and Special Tools
For
TEST SET, CONVERTER SUBASSEMBLY-VIDEO CONVERTER
AN / AAM-35
(NSN 6625-00-403-1064)
Current as of 23 October 1975

SECTION		Page	Illus Figure
	I Introduction	1	
	II Repair parts lists	5	
Group	00 Test Set, Converter Subassembly-Video Converter AN/AAM-35	5	1
	1 Test set, converter subassembly, unit 1	5	2
	1A1 Control unit No. 1	5	3
	1A1A1 Power supply, -15 Vdc	9	4
	1A1A2 Power supply, Ic	9	5
	1A1A3 1A1A4. Power supply, +150/250 Vdc	14	6
	1A1A5 Filament supply, storage tube	16	7
	1A1A6 Power control, TC1 and Cs-Vc	18	8
	1A1A7 Simulator, Cs-Vc	18	9
	1A1A8 Video interface	21	10
	1A1A9 Synchronous interface	23	11
	1A1A10 Generator, hot spot	23	12
	1A1A11 Loads board No 1	26	13
	1A1A12 Loads board No 2	26	14
	1A1A13 Assembly, heatsink	26	15
	1A1A14 Assembly, heatsink	26	16
	1A1A15 Assembly, filter	32	17
	1W Cable assemblies	32	18
Group	2 Test set, converter subassembly unit 2	32	19
	2A1 Control unit 2	36	20
	2A1A1 Oscillator, 100 KHz	37	21
	2A1A2 Generator, synchronous	42	22
	2A1A3 Generator, read vertical sweep	42	23
	2A1A4 Generator, write horizontal sweep	44	24
	2A1A5 Slew write horizontal and field-of-view adder	48	25
	2A1A6 Amplifier, write video	49	26
	2A1A7 Generator, velocity/height clock pulse	51	27
	2A1A8 Generator, write vertical sweep	53	28
	2A1A9 Generator, erase vertical sweep	55	29
	2A1A10 Logic auxiliary deflection	58	30
	2A1A11 Generator, dither	60	31
	2A1A12 Sweep and blanking, generator Cs-Vc	62	32
	2A1A13 Storage tube protect, loads and video amplifier	64	33

		Page	Illus Figure
	2A1A14 Power supply +15 Vdc	66	34
	2A1A15 Assembly, heatsink	66	35
	2W Cable assemblies	66	36
SECTION	III Special tools list (not applicable)		
	IV FSN, Part No Index	72	

SECTION I

INTRODUCTION

1. Scope

This manual lists repair parts; and other support equipment required for operation and performance of general support and depot maintenance of the Test Set, Converter Subassembly-Video Converter AN/AAM-35

2. General

This Repair Parts List is divided into the following sections.

a Section II. Repair Parts List. A list of repair parts authorizes for use in performance of maintenance. The list also includes parts which must be removed for replacement of the authorized parts. Parts lists are composed of functional groups in ascending numerical sequence, with the parts in each group listed in figure and item number sequence.

b. Section III. Special Tools List Not applicable.

c Section IV Federal Stock Number and Part Number Index A list, in ascending numerical sequence, of all Federal stock numbers appearing in the listings, followed by a list, in alphameric sequence, of all part numbers appearing in the listings. Federal stock number and part numbers are cross-referenced to each illustration figure and item number appearance.

3. Explanation of Columns

The following provides an explanation of columns found in the tabular listings:

a Illustration This column is divided as follows:

(1) *Figure Number.* Indicates the figure number of the illustration in which the item is shown.

(2) *Item Number.* The number used to identify each item called out in the illustration.

b Source, Maintenance, and Recoverability Codes (SMR).

(1) *Source Code.* Source codes are assigned to support items to indicate the manner of acquiring support items for maintenance, repair, or overhaul of end items. Source codes are entered in the first and second positions of the Uniform SMR Code format as follows

<i>Code</i>	<i>Definition</i>
-------------	-------------------

PA—Item procured and stocked for anticipated or known usage

PD—Support item, excluding support equipment, procured for initial issue or outfitting and

Code

Definition

stocked only for subsequent or additional initial issues or outfittings. Not subject to automatic replenishment.

XA—Item is not procured or stocked because the requirements for the item will result in the replacement of the next higher assembly

XB—Item is not procured or stocked. If not available through salvage, requisition

H—The lowest maintenance level capable of complete repair of the support item is the general support level

D—The lowest maintenance level capable of complete repair of the support item is the depot level, performed by depot.

Z - Nonreparable. No repair is authorized

(2) *Recoverability Code.* Recoverability codes are assigned to support items to indicate the disposition action on unserviceable items. The recoverability code is entered in the fifth position of the Uniform SMR Code format as follows:

<i>Recoverability Code</i>	<i>Definition</i>
----------------------------	-------------------

Definition

Z—Nonreparable item. When unserviceable, condemn and dispose at the level indicated in position 3

NOTE

Cannibalization or salvage may be used as a source of supply for any items source coded above except those coded XA, XD, and aircraft support items as restricted by AR 700-42

(3) *Maintenance Code* Maintenance codes are assigned to indicate the levels of maintenance authorized to USE and REPAIR support items. The maintenance codes are entered in the third and fourth positions of the Uniform SMR Code format as follows:

(a) This maintenance code entered in the third position will indicate the lowest maintenance level authorized to remove, replace, and use the support item. The maintenance code entered in the third position will indicate one of the following levels of maintenance:

<i>Code</i>	<i>Application/Explanation</i>
O	Support item is removed, replaced, used at the organizational level.
H	Support item is removed, replaced, used at the general support level.
D	Support items that are removed, replaced, used at depot, mobile depot, specialized repair activity only.

(b) The maintenance code entered in the fourth position indicates whether the item is to be repaired and identifies the lowest maintenance level with the capability to perform complete repair (i.e., all authorized maintenance functions). This position will contain one of the following maintenance codes:

<i>Recoverability Codes</i>	<i>Definition</i>
D	Reparable item. When beyond lower level repair capability, return to depot. Condemnation and disposal not authorized below depot level

c. *Federal Stock Number.* Indicates the Federal stock number assigned to the item.

NOTE

For requisitioning purposes, the Federal stock number must be converted to the National stock number by adding "-00-" after the Federal stock classification (FSC) code (first four digits). For example, FSN 6625-553-0142 converts to NSN 6625-00-553-0142.

d. *Part Number* Indicates the primary number used by the manufacturer (individual, company, firm, corporation, or Government activity), which controls the design and characteristics of the item by means of its engineering drawings, specifications standards and inspection requirements, to identify an item or range of items.

NOTE

When a stock numbered item is requisitioned, the repair part received may have a different part number than the part being replaced.

e. *Federal Supply Code for Manufacturer (FSCM)* The FSCM is a 5-digit numeric code listed in SB 708-42 which is used to identify the manufacturer, distributor, or Government agency, etc

f. *Description* Indicates the Federal item name and, if required, a minimum description to identify the item

g. *Unit of Measure (U/M)*. Indicates the standard of the basic quantity of the listed item as used in performing the actual maintenance function. This measure is expressed by a two-character

alphabetical abbreviation (e.g., ea, in, pr, etc.). When the unit of measure differs from the unit of issue, the lowest unit of issue that will satisfy the required units of measure will be requisitioned.

h. *Quantity Incorporated in Unit* Indicates the quantity of the item used in the breakout shown on the illustration figure, which is prepared for a functional group.

4. Special Information

The following publications pertain to the Test Set, Converter Subassembly-Video Converter AN/AAM-35 and its components:

TM 11-6625-1824-12	Operator's and organizational maintenance manual including repair parts and special tools lists: Test Set, Converter Subassembly-Video Converter AN/AAM-35.
TM 11-6625-1824-40	General support maintenance manual: Test Set, Converter Subassembly-Video Converter AN/AAM-35
TM 11-6625-1824-50	Depot maintenance manual: Test Set, Converter Subassembly-Video Converter AN/AAM-35 (FSN 6626-403-1064)

5. How to Locate Repair Parts

a. *When Federal Stock Number or Part Number is Unknown.*

(1) *First* Using the table of contents, determine the functional group within which the repair part belongs. This is necessary since illustrations are prepared for functional groups, and listings are divided into the same groups.

(2) *Second* Find the illustration covering the functional group to which the repair part belongs.

(3) *Third* Identify the repair part on the illustration and note the illustration figure and item number of the repair part.

(4) *Fourth* Using the Repair Parts Listing, find the figure and item number noted on the illustration.

b. *When Federal Stock Number or Part Number is Known*

(1) *First* Using the Index of Federal Stock Numbers and Part Numbers, find the pertinent Federal stock number or part number. This index is

in ascending FSN sequence followed by a list of part numbers in ascending alphameric sequence, cross-referenced to the illustration figure number and item number.

(2) *Second.* After finding the figure and item number, locate the figure and item number in the repair parts list.

6. Abbreviations

Not applicable.

7. Recommendation for Maintenance Publication Improvements

You can help to improve this manual by calling attention to errors and by recommending improvements. Your letter or DA Form 2028 (Recommended Changes to Publications and Blank Forms) should be mailed directly to Commander, US Army Electronics Command, ATTN: AMSEL-MA-Q, Fort Monmouth, NJ 07703. A reply will be furnished direct to you.

SECTION II REPAIR PARTS LIST

(1) ILLUSTRATION		(2) SMR CODE	(3) FEDERAL STOCK NUMBER	(4) PART NUMBER	(5) FSCM	(6) DESCRIPTION	(7) UNIT OF MEAS	(8) QTY INC IN UNIT
(A) FIG NO.	(B) ITEM NO.					USABLE ON CODE		
GROUP 00 TEST SET, CONVERTER SUBASSEMBLY-								
VIDEO CONVERTER AN/AAM-35								
1	1	FD0DD		692581-1	96214	TEST SET, CONVERTER SUBASSEMBLY, NO. 1	EA	1
1	2	FD0DD		692580-1	96214	TEST SET, CONVERTER SUBASSEMBLY, NO. 2	EA	1
GROUP 1 TEST SET, CONVERTER SUBASSEMBLY, UNIT 1								
2	1	XBOZZ	6626-180-7641	CW1108/AAM-35	80058	COVER, TEST SET SUBASSEMBLY	EA	1
2	2	FD0DD	6625-408-5053	MX2748/AAM-35	80058	TEST SET SUBASSEMBLY	EA	1
2	3	VAHED		692597-1	96214	ELECTRONIC CONTROL UNIT, NO 1	EA	1
GROUP 1A1 CONTROL UNIT NO. 1								
3	1	PAHED	5915-194-4876	694753-2	96214	FILTER ASSEMBLY	EA	1
3	2	PAHZZ	5935-762-0312	M39024-10-03	81349	JACK, TIP	EA	1
3	3	PAHZZ	5935-702-4199	M39024-10-02	81349	JACK, TIP	EA	11
3	4	PAHZZ	5905-883-9168	RE70G1212	81349	RESISTOR, FIXED, WIREWOUND	EA	4
3	5	PAHZZ	5935-410-9250	M24308-2-3	81349	CONNECTOR, RECEPTACLE, ELECTRICAL	EA	1
3	6	PAHZZ	5940-905-4576	SE209D01	81349	TERMINAL, STUD	EA	14
3	7	PAHZZ	5945-068-3927	KJ2A006	35344	RELAY, ARMATURE	EA	4
3	8	PAHZZ	5961-723-3602	1N3612	81349	SEMICONDUCTOR DEVICE, DIODE	EA	5
3	9	PAHZZ	5945-490-5199	GSE22-501-0013	2-727	RELAY, DETECTOR, ELECTRONIC	EA	1
3	10	PAHZZ	5905-838-8399	PW78U4752F	81349	RESISTOR, FIXED, WIREWOUND	EA	2
3	11	PAHZZ	5905-414-2545	RW78V18S72F	81349	RESISTOR, FIXED, WIREWOUND	EA	1
3	12	PAHDD	6130-433-2345	725081-1	96214	POWER SUPPLY, -15 VDC	EA	1
3	13	PAHDD	6130-4801-244	725084-1	96214	POWER SUPPLY, INTEGRATED CIRCUIT	EA	1
3	14	PAHDD	6625-408-5055	692469-1	96214	POWER SUPPLY +150/250 VDC	EA	2
3	15	PAHDD	6130-493-9265	725087-1	96214	FILAMENT SUPPLY, STORAGE TUBE	EA	1
3	16	PAHZZ	5905-432-9189	PW78U7682F	81349	RESISTOR, FIXED, WIREWOUND	EA	2
3	17	PAHDD	6625-409-8160	692367-1	96214	POWER CONTROL TC1 AND CS-CV	EA	1
3	18	PAHDD	6625-409-8162	692412-1	96214	SIMULATOR, CS-CV	EA	1
3	19	PAHZZ	6625-462-3969	725090-1	96214	VIDEO INTERFACE	EA	1
3	20	PAHDD	6625-409-0995	692466-1	96214	SYNCHRONOUS INTERFACE	EA	1
3	21	PAHDD	6625-197-6384	692400-1	96214	GENERATOR, HOT SPOT	EA	1
3	22	PAHDD	6625-403-1082	692406-1	96214	LOADS, BOARD NO 1	EA	1
3	23	PAHDD	6625-403-1083	692409-1	96214	LOADS, BOARD NO 2	EA	1
3	24	PAHZZ	5940-687-2477	MS77069-1	96906	TERMINAL, LUG	EA	4
3	25	PAHZZ	5905-866-4366	RE60G16R2	81349	RESISTOR, FIXED, WIREWOUND	EA	1
3	26	PAHZZ	5905-934-3134	RE60G30R1	81349	RESISTOR, FIXED, WIREWOUND	EA	1
3	27	PADZZ		530537-41	96214	CAPACITOR	EA	1
3	28	PAHZZ	5961-957-6865	1N3611	81349	SEMICONDUCTOR DEVICE, DIODE	EA	1
3	29	PAHZZ	5950-493-9397	636229-1	96214	TRANSFORMER, POWER, THREE PHASE	EA	1
3	30	PAHDD	6110-89-0410	695916-1	96214	ASSEMBLY, HFATSINK	EA	1
3	31	PAHZZ	5935-490-5220	M24308-2-2	81349	CONNECTOR, RECEPTACLE, ELECTRICAL	EA	1
3	32	PAHZZ	5905-728-7855	RE75G3322	81349	RESISTOR, FIXED, WIREWOUND	EA	1
3	33	PAHZZ	5905-057-5089	RE75G1302	81349	RESISTOR, FIXED, WIREWOUND	EA	1
3	34	PAHZZ	5905-225-9756	RE75G1872	81349	RESISTOR, FIXED, WIREWOUND	EA	1

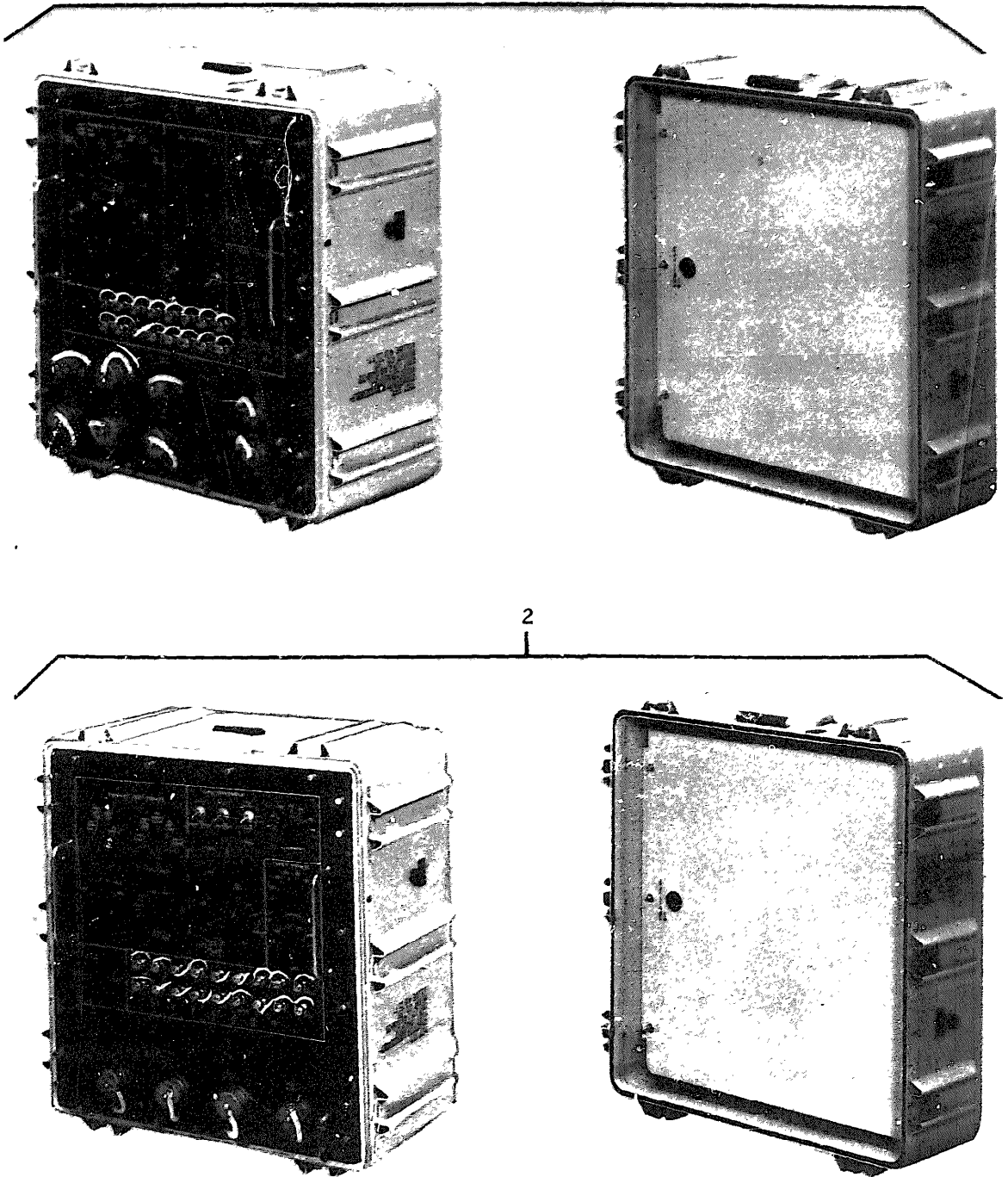

EL 6625-1824-40P-TM-1

Figure 1. Test Set Converter AN/AAM-35

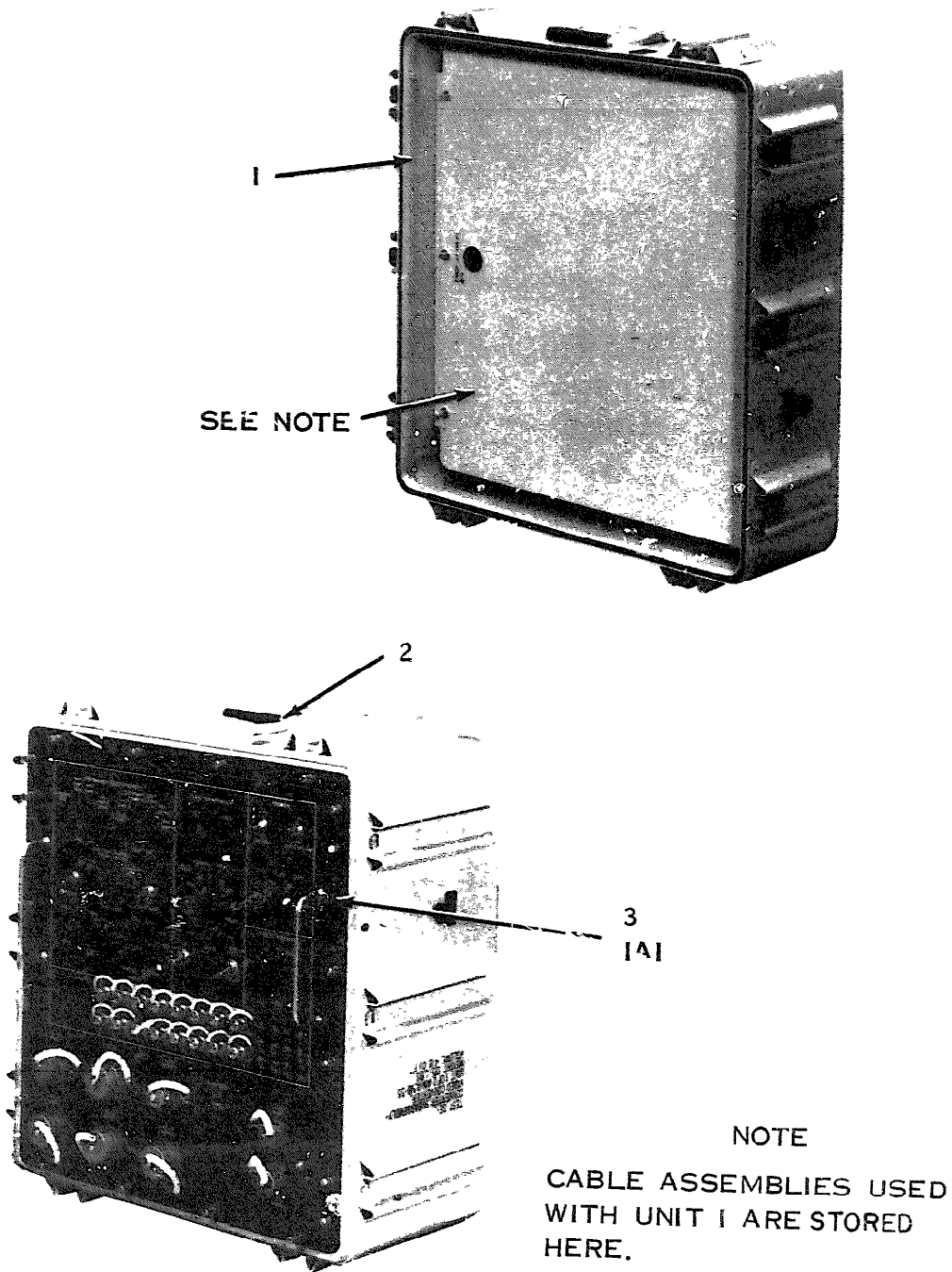

EL 6625-1824-40P-TM-2

Figure 2. Test set converter subassembly unit 1

SECTION II REPAIR PARTS LIST (CONTINUED)

(1) ILLUSTRATION		(2) SMR CODE	(3) FEDERAL STOCK NUMBER	(4) PART NUMBER	(5) FSCM	(6) DESCRIPTION	(7) UNIT OF MEAS	(8) QTY INC IN UNIT
(A) FIG NO.	(B) ITEM NO							
3	35	PAHZZ	490-499-3111	REPLACEMENT	81149	RESISTOR, FIXED, WIREWOUND	EA	1
3	36	PAHZZ	6110-488-5307	69211-11	96211	ASSEMBLY, PLATING	EA	1
3	37	PAHZZ	5935-260-2686	4079-4	41236	CONNECTOR, RECEPTACLE, ELECTRICAL	EA	1
3	38	PAHZZ		418623-62	96214	SWITCH, ROTARY	EA	1
3	39	PAHZZ	5930-455-2582	MS35059-23	96906	SWITCH, TOGGLE	EA	1
3	40	PAHZZ	5930-421-8973	19-4963-1	91212	SWITCH, ROTARY	EA	1
3	41	PAHZZ	6241-455-7896	MS25237-120	91906	LAMP, INCANDESCENT	EA	1
3	42	PAHZZ	6210-482-3871	JB-832P3-R3	87734	LAMP-HOLDER	EA	1
3	43	PAHZZ		A-83233-R3	87734	LAMP-HOLDER	EA	1
3	44	PAHZZ	5910-251-0712	MX96194-1-50	81349	CIRCUIT BREAKER	EA	1
3	45	PAHZZ	6010-481-1871	60-4323-R1	87034	LAMP-HOLDER	EA	1
3	46	PAHZZ	5935-489-1233	REPOSDF03ACV	97954	CONNECTOR, PLUG, ELECTRICAL	EA	1
3	47	PAHZZ	0940-419-8743	197080-1	91214	TERMINAL STRIP	EA	1
3	48	PAHZZ	1935-407-1111	REPOSDF03ACV	97954	CONNECTOR, PLUG, ELECTRICAL	EA	1
3	49	PAHZZ	5925-418-1090	MS36019-1-32	81349	CIRCUIT BREAKER	EA	1
3	50	PAHZZ	5935-489-1887	REPOSDF03ACV	97954	CONNECTOR, PLUG, ELECTRICAL	EA	1
3	51	PAHZZ	5935-24-2060	REPOSDF03ACV	97954	CONNECTOR, PLUG, ELECTRICAL	EA	1
3	52	PAHZZ	5930-229-7796	418630-01	96214	SWITCH, ROTARY	EA	1
3	53	PAHZZ	5940-980-6019	377B18	81349	TERMINAL STRIP	EA	1
3	54	PAHZZ	5930-421-7763	418633-01	96211	SWITCH, ROTARY	EA	1
3	55	PAHZZ	5935-497-0330	REPOSDF03ACV	97954	CONNECTOR, PLUG, ELECTRICAL	EA	1
3	56	PAHZZ	5905-851-974	PA2054CV5014	81349	RESISTOR, VARIABLE, WIREWOUND	EA	1
3	57	PAHZZ	5935-236-7707	REPOSDF03ACV	97954	CONNECTOR, PLUG, ELECTRICAL	EA	1
3	58	PAHZZ	5935-212-2764	REPOSDF03ADM	97954	CONNECTOR, PLUG, ELECTRICAL	EA	1
3	59	PAHZZ	5935-240-2764	REPOSDF03ADD	97954	CONNECTOR, PLUG, ELECTRICAL	EA	1
3	60	PAHZZ	5935-206-7719	REPOSDF03AE	97954	CONNECTOR, PLUG, ELECTRICAL	EA	1
3	61	PAHZZ	5935-241-7707	REPOSDF03AEF	97954	CONNECTOR, PLUG, ELECTRICAL	EA	1
3	62	PAHZZ	5935-236-7726	REPOSDF03AF	97954	CONNECTOR, PLUG, ELECTRICAL	EA	1
3	63	PAHZZ	5930-452-8502	418633-69	96214	SWITCH, ROTARY	EA	1
3	64	PAHZZ	5930-350-1772	418633-67	96214	SWITCH, ROTARY	EA	1
3	65	PADZZ	5905-071-2315	RM65D1300F	81349	RESISTOR, FIXED, FILM	EA	1
3	66	PADZZ	5961-762-0201	1N5550	81349	SEMICONDUCTOR DIODE, ZENER	EA	1
3	67	PAHZZ	5930-615-7880	MS35059-16	96906	SWITCH, TOGGLE	EA	1
3	68	PAHZZ	5930-189-4335	418623-66	96214	SWITCH, ROTARY	EA	1
3	69	PAHZZ	5935-784-5968	MS3124E1-41S	96906	CONNECTOR, RECEPTACLE, ELECTRICAL	EA	1
3	70	PAHZZ	5935-784-5912	MS3124E2-55F	96906	CONNECTOR, RECEPTACLE, ELECTRICAL	EA	1
3	71	PAHZZ	5935-775-4493	MS3124E2-55FE	96906	CONNECTOR, RECEPTACLE, ELECTRICAL	EA	1
3	72	PAHZZ	5935-240-7724	1227E95E21	99922	CONNECTOR BODY, RECEPTACLE, ELECTRICAL	EA	1
3	73	PADZZ	5935-689-1815	1227E95E21	99922	CONNECTOR BODY, RECEPTACLE, ELECTRICAL	EA	1
3	74	PAHZZ	5935-715-4484	MS3124E1-41	96906	CONNECTOR, RECEPTACLE, ELECTRICAL	EA	1
3	75	PAHZZ	6645-475-4305	519649-	96714	METER, TIME TOTALIZING, MECHANICAL	EA	1
3	76	PAOZZ	5355-985-6888	MS91528-21B	96906	KNOB, CONTROL	EA	1
3	77	PAOZZ	5355-567-8580	MS91528-21C	96906	KNOB, CONTROL	EA	1

SECTION II REPAIR PARTS LIST (CONTINUE)

(1) ILLUSTRATION		(2) SMR CODE	(3) FEDERAL STOCK NUMBER	(4) PART NUMBER	(5) FSCM	(6) DESCRIPTION	(7) UNIT OF MEAS	(8) QTY INC IN UNIT
(A) FIG NO.	(B) ITEM NO.							
3	78	VERFF		692583-1	96214	PLATE, IDENTIFICATION	EA	1
GROUP 1A1A1 POWER SUPPLY -15VDC								
4	1	PADZZ	5910-113-5540	CK15BX104K	81349	CAPACITOR, FIXED, CERAMIC DIELECTRIC	EA	7
4	2	PADZZ	5910-887-9874	CM05FD221J03	81349	CAPACITOR, FIXED, ELECTROLYTIC	EA	1
4	3	PADZZ	5910-460-0869	CM05FD221J03	81349	CAPACITOR, FIXED, MICA DIELECTRIC	EA	1
4	4	PADZZ	5910-010-8718	CK06BX104K	81349	CAPACITOR, FIXED, CERAMIC DIELECTRIC	EA	1
4		PADZZ	5910-165-2742	CL65BG101MPE	81349	CAPACITOR, FIXED, ELECTROLYTIC	EA	1
4	6	PADZZ	5961-762-0201	1N5550	81349	SEMICONDUCTOR DEVICE, DIODE	EA	6
4	7	PADZZ	5961-836-6667	1N816	81349	SEMICONDUCTOR DEVICE, DIODE	EA	2
4	8	PADZZ	5961-842-9864	1N914	81349	SEMICONDUCTOR DEVICE, DIODE	EA	2
4	9	PADZZ	5961-923-3940	1N825	81349	SEMICONDUCTOR DEVICE, DIODE	EA	1
4	10	PADZZ	5999-484-5511	7717-18N	13103	INSULATOR, DISK	EA	2
4	11	PADZZ	5961-054-0339	7717-19DAP	13103	INSULATOR, DISK	EA	1
4	12	PADZZ	5935-131-9696	M39024-11-04	81349	JACK, TIP	EA	1
4	13	PADZZ	5935-131-9681	M39024-11-02	81349	JACK, TIP	EA	1
4	14	PADZZ	5935-131-9726	M39024-11-06	81349	JACK, TIP	EA	1
4	15	PADZZ	5935-231-9698	M39024-11-03	81349	JACK, TIP	EA	1
4	16	PADZZ	5935-236-7729	UPCCSGM23AACM	97954	CONNECTOR, RECEPTACLE, ELECTRICAL	EA	1
4	17	PADZZ	5961-913-2747	2N2907	81349	TRANSISTOR	EA	1
4	18	PADZZ	5961-951-8757	2N2222A	81349	TRANSISTOR	EA	1
4	19	PADZZ	5905-432-6410	RN60D1001F	81349	RESISTOR, FIXED, FILM	EA	4
4	20	PADZZ	5905-983-6914	RN60D1002F	81349	RESISTOR, FIXED, FILM	EA	2
4	21	PADZZ	5905-758-2063	RN60D2210F	81349	RESISTOR, FIXED, FILM	EA	1
4	22	PADZZ	5905-138-1285	RN60D2001F	81349	RESISTOR, FIXED, FILM	EA	2
4	23	PADZZ	5905-763-9237	PW68VR13	81349	RESISTOR, FIXED, WIREWOUND	EA	1
4	24	PADZZ	5905-758-4840	RN60D1501F	81349	RESISTOR, FIXED, FILM	EA	1
4	25	PADZZ	5905-409-7252	RN60C2611F	81349	RESISTOR, FIXED, FILM	EA	1
4	26	PADZZ	5905-196-1020	RT24CP501	81349	RESISTOR, VARIABLE, WIREWOUND	EA	1
4	27	PADZZ	5905-451-7518	RN60C1961F	81349	RESISTOR, FIXED, FILM	EA	1
4	28	PADZZ	5962-148-2858	SN52709L	01295	INTEGRATED CIRCUIT, OPERATIONAL AMPLIFIER	EA	1
GROUP 1A1A2 POWER SUPPLY, IC								
5	1	PADZZ	5910-113-5499	CK06BX104K	81349	CAPACITOR, FIXED, CERAMIC DIELECTRIC	EA	6
5	2	PADZZ	5910-1113-5540	CK15BX104K	81349	CAPACITOR, FIXED, CERAMIC DIELECTRIC	EA	1
5	3	PADZZ	5910-006-6972	CL65BG101MPE	81349	CAPACITOR, FIXED, ELECTROLYTIC	EA	1
5	4	PADZZ	5910-490-0397	CM05ED470J03	81349	CAPACITOR, FIXED, MICA DIELECTRIC	EA	1
5	5	PADZZ	5910-481-1626	CM06FD472J03	81349	CAPACITOR, FIXED, MICA DIELECTRIC	EA	1
5	6	PADZZ	5910-936-1332	CSR13F685KL	81349	CAPACITOR, FIXED, ELECTROLYTIC	EA	1
5	7	PADZZ	5910-144-4379	CSR13E125KL	81349	CAPACITOR, FIXED, ELECTROLYTIC	EA	1
5	8	PADZZ	5961-957-6865	1N3611	81349	SEMICONDUCTOR DEVICE, DIODE	EA	6
5	9	PADZZ	5961-836-6667	1N816	81349	SEMICONDUCTOR DEVICE, DIODE	EA	2
5	10	PADZZ	5961-842-9864	1N914	81349	SEMICONDUCTOR DEVICE, DIODE	EA	2
5	11	PADZZ	5961-923-3940	1N825	81349	SEMICONDUCTOR DEVICE, DIODE	EA	1
5	12	ABLZZ	5961-799-5539	2209-4A	13103	HEAT SINK, ELECTRICAL	EA	1

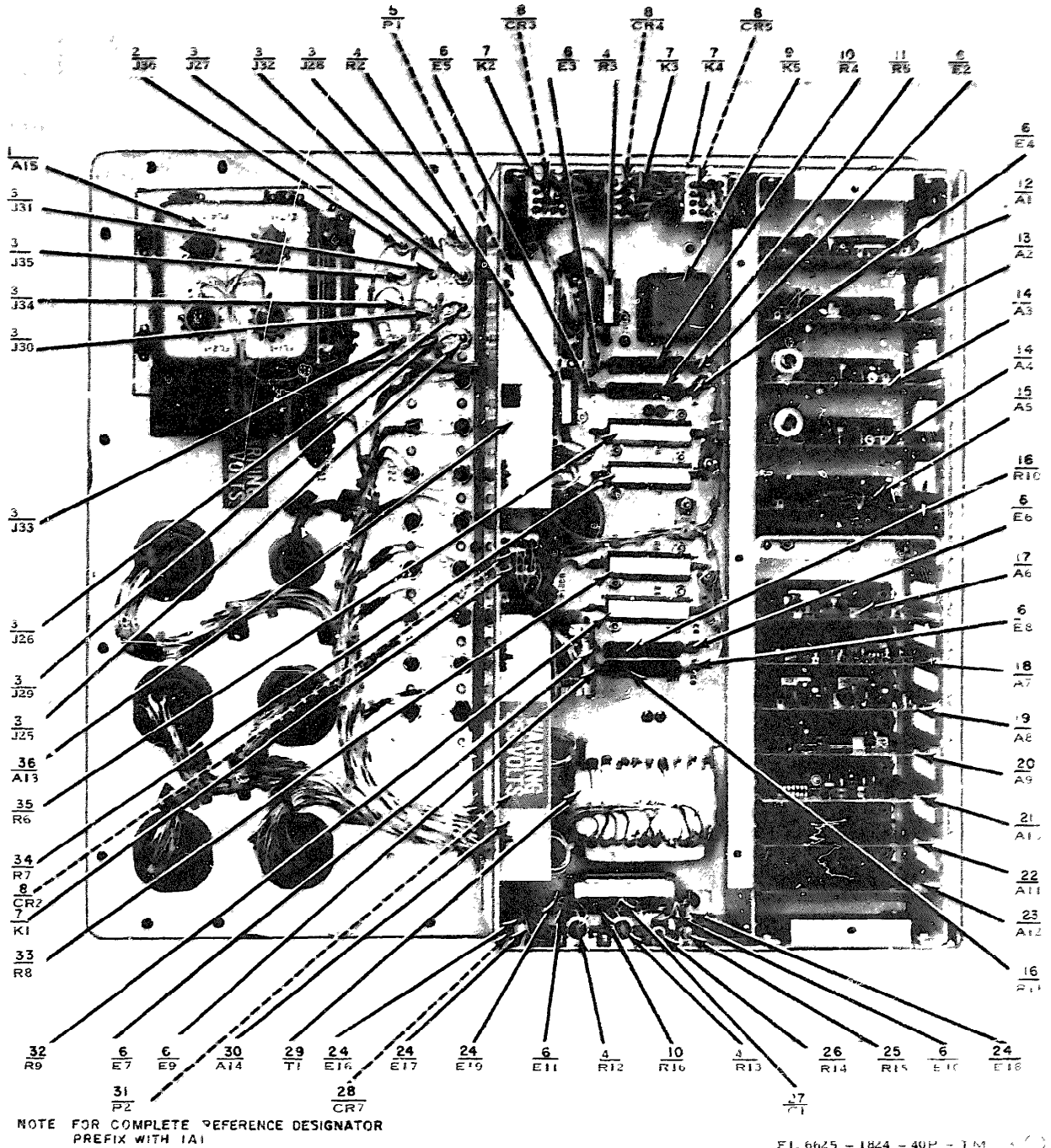

Figure 3 (1) Control unit No 1 (sheet 1 of 3)

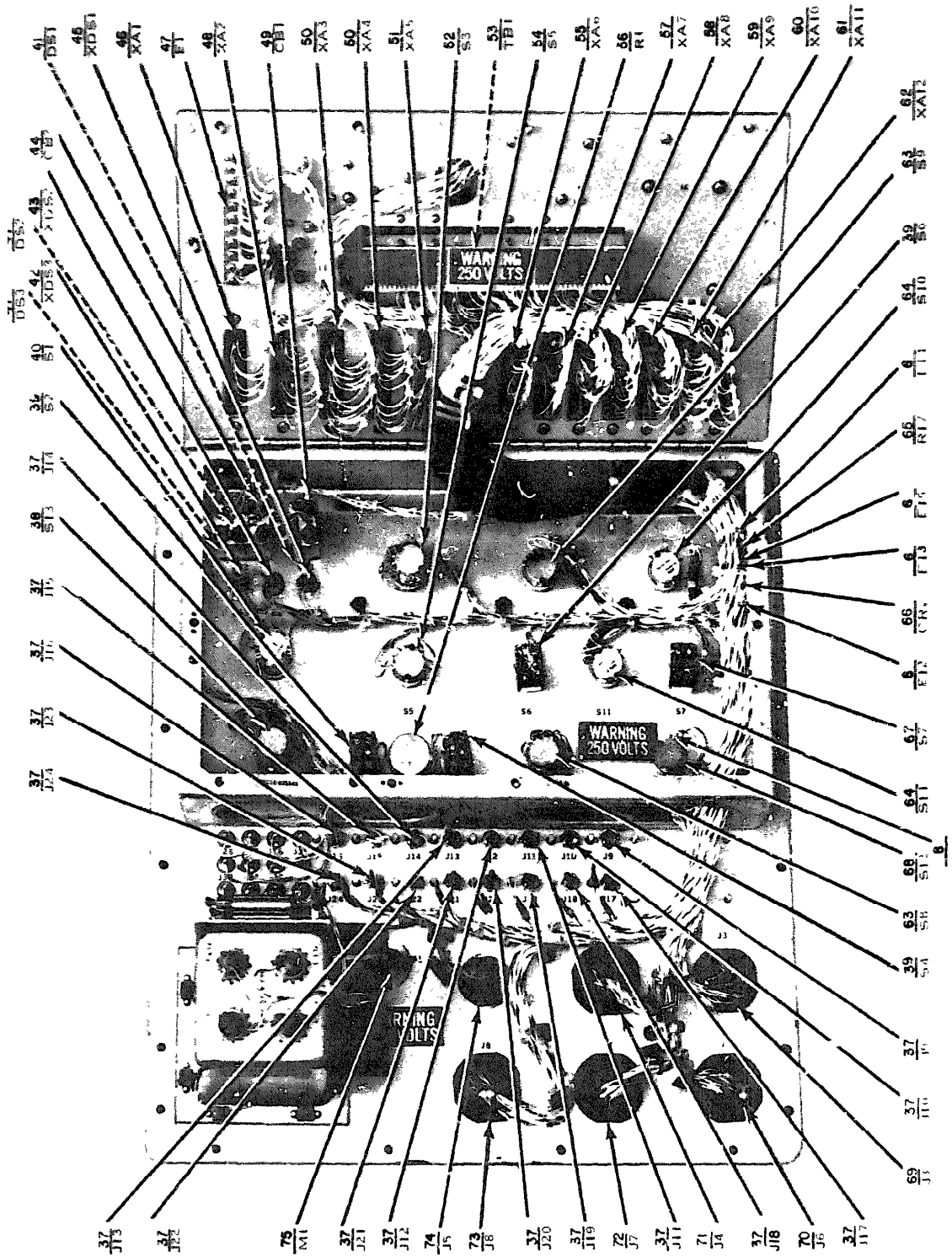
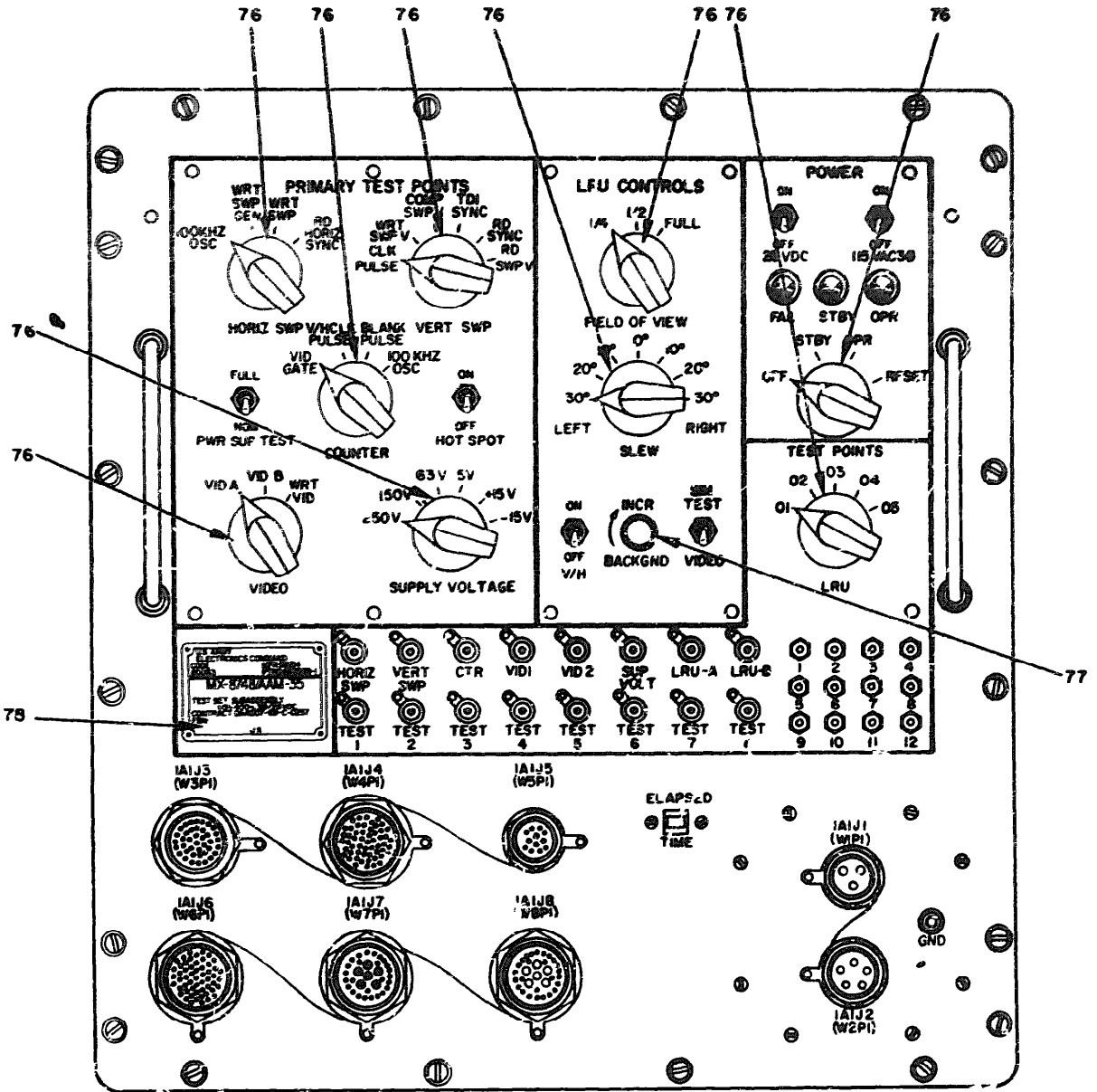
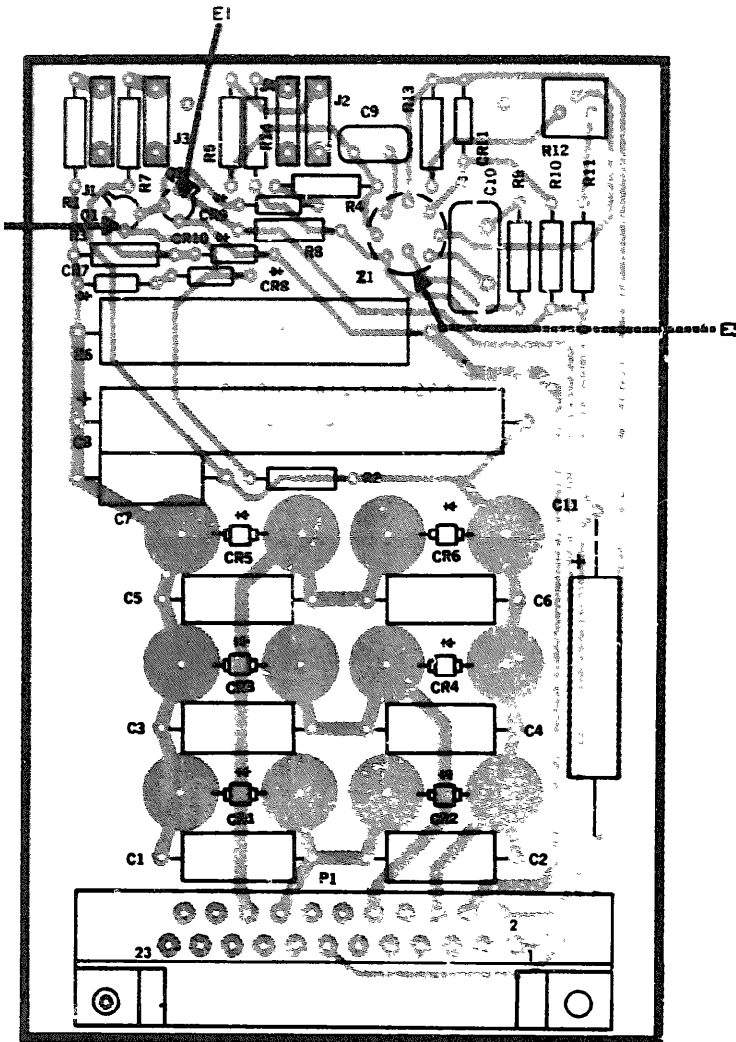

Figure 3. Control unit No 1 (sheet 2 of 3)



EL6625-1824-40P-TM-3 ⑤

Figure 3 ③ Control unit No 1 (sheet 3 of 3)



REF DES	ITEM NO	REF DES	ITEM NO	REF DES	ITEM NO	REF DES	ITEM NO
C1	1	CR2	6	E3	11	R5	19
C2	1	CR3	6	J1	12	R6	23
C3	1	CR4	6	J2	13	R7	19
C4	1	CR5	6	J3	14	R8	20
C5	1	CR6	6	J4	15	R9	24
C6	1	CR7	7	P1	16	R10	22
C7	1	CR8	7	Q1	17	R11	25
C8	2	CR9	8	Q2	18	R12	26
C9	3	CR10	8	R1	19	R13	27
C10	4	CR11	9	R2	20	R14	19
C11	5	E1	10	R3	21	Z1	28
CR1	6	E2	10	R4	22		

LEGEND

BASING DIAGRAMS ARE SHOWN FROM THE TOP AS ON THE PART LOCATION DIAGRAM.

TRANSISTOR (Q)

OPERATIONAL AMPLIFIER (Z)

NOTE:

1. LIGHT SHADING INDICATES ETCHED SIDE CIRCUIT PATTERN-DARK SHADING INDICATES COMPONENT SIDE PATTERN.
2. FOR COMPLETE REFERENCE DESIGNATION PREFIX WITH 1A1A1
3. E1, E2, AND E3 ARE INSULATOR DISKS LOCATED UNDER THE COMPONENTS AS INDICATED.

EL6625-1824-40P-TM-4

Figure 4 Power Supply - 15 VDC

SECTION II REPAIR PARTS LIST (CONTINUED)

(1) ILLUSTRATION		(2) SMR CODE	(3) FEDERAL STOCK NUMBER	(4) PART NUMBER	(5) FSCM	(6) DESCRIPTION	(7) UNIT OF MEAS	(8) QTY INC IN UNIT
(A) FIG NO.	(B) ITEM NO.							
5	13	PADZZ	5999-484-5513	7717-18N	13103	INSULATOR, DISK	EA	3
5	14	PADZZ	5961-054-0339	7717-19DAP	13103	INSULATOR, DISK	EA	1
5	15	XEEZZ	5961-476-6203	6111B1-10	13103	HEAT SINK, ELECTRICAL-ELECTRONIC	EA	1
5	16	PADZZ	5935-131-9696	M39024-11-04	81349	JACK, TIP	EA	1
5	17	PADZZ	5935-131-9681	M39024-11-02	81349	JACK, TIP	EA	1
5	18	PADZZ	5935-131-9726	M39024-11-06	81349	JACK, TIP	EA	1
5	19	PADZZ	5935-131-9693	M39024-11-03	81349	JACK, TIP	EA	1
5	20	PADZZ	5935-689-1891	JP003243AACN	97954	CONNECTOR, RECEPTACLE, ELECTRICAL	EA	1
5	21	PADZZ	5961-925-3777	2N2907A	81349	TRANSISTOR	EA	1
5	22	PADZZ	5961-951-6757	2N2222A	81349	TRANSISTOR	EA	1
5	23	PAHZZ	5961-923-3951	2N2191	81349	TRANSISTOR	EA	1
5	24	PADZZ	5961-184-9893	2N3506	81349	TRANSISTOR	EA	1
5	25	PADZZ	5985-972-4687	RW70M1900F	81349	RESISTOR, FIXED, WIREWOUND	EA	1
5	26	PADZZ	5905-432-6420	RN60D1001F	81349	RESISTOR, FIXED, FILM	EA	1
5	27	PADZZ	5905-758-4840	RN60D1501F	81349	RESISTOR, FIXED, FILM	EA	1
5	28	PADZZ	5905-028-1832	RN60D1301F	81349	RESISTOR, FIXED, FILM	EA	1
5	29	PADZZ	5905-990-4152	RW69V1P8	81349	RESISTOR, FIXED, WIREWOUND	EA	1
5	30	PADZZ	5905-138-1285	RN60D2001F	81349	RESISTOR, FIXED, FILM	EA	1
5	31	PADZZ	5905-983-6914	RN60D1002F	81349	RESISTOR, FIXED, FILM	EA	1
5	32	PADZZ	5905-261-7693	RN60D1621F	81349	RESISTOR, FIXED, FILM	EA	1
5	33	PADZZ	5905-233-7141	RN60D2741F	81349	RESISTOR, FIXED, FILM	EA	1
5	34	PADZZ	5905-189-2467	RN60D3011F	81349	RESISTOR, FIXED, FILM	EA	1
5	35	PADZZ	5905-879-6336	RT2402P102	81349	RESISTOR, VARIABLE, WIREWOUND	EA	1
5	36	PADZZ	5905-405-0955	RN60C2871F	81349	RESISTOR, FIXED, FILM	EA	1
5	37	PADZZ	5905-468-5847	RN60C1531F	81349	RESISTOR, FIXED, FILM	EA	1
5	38	PADZZ	5905-232-7791	RN60D1500F	81349	RESISTOR, FIXED, FILM	EA	1
5	39	PADZZ	5905-482-0618	PW8L11210F	81349	RESISTOR, FIXED, WIREWOUND	EA	1
5	40	PADZZ	5962-148-2858	SN52709L	01295	INTEGRATED CIRCUIT, OPERATIONAL AMPLIFIER	EA	1
5	41	PADZZ	5940-082-5002	SE144001	81349	TERMINAL, STUD	EA	1
GROUP 1A1A3 LALA4 POWER SUPPLY .50/250 VDC								
6	1	PADZZ	5910-487-8424	CM05FD391J03	81349	CAPACITOR, FIXED, MICA DIELECTRIC	EA	1
6	2	PADZZ	5910-113-9453	CM06B105K	81349	CAPACITOR, FIXED, CERAMIC DIELECTRIC	EA	1
6	3	PADZZ	5910-144-4383	CSR13F2264L	81349	CAPACITOR, FIXED, ELECTROLYTIC	EA	1
6	4	PADZZ	5910-490-0397	CM05ED470J03	81349	CAPACITOR, FIXED, MICA DIELECTRIC	EA	1
6	5	PADZZ	5910-010-8718	CM06B103K	81349	CAPACITOR, FIXED, CERAMIC DIELECTRIC	EA	1
6	6	PADZZ	5910-113-5499	CM06B104K	81349	CAPACITOR, FIXED, CERAMIC DIELECTRIC	EA	1
6	7	PADEZ	5910-211-2503	CM09A1NF474K	81349	CAPACITOR, FIXED, PAPER DIELECTRIC	EA	1
6	8	PADZZ	5961-059-2904	1N7613	81349	SEMICONDUCTOR DEVICE, DIODE	EA	1
6	9	PADZZ	5961-852-7549	1N764A	81349	SEMICONDUCTOR DEVICE, DIODE	EA	1
6	10	PADZZ	5961-842-9864	1N914	81349	SEMICONDUCTOR DEVICE, DIODE	EA	1
6	11	PADZZ	5961-892-0889	1N938B	81349	SEMICONDUCTOR DEVICE, DIODE	EA	1
6	12	PADZZ	5961-879-2474	1N3028B	81349	SEMICONDUCTOR DEVICE, DIODE	EA	1
6	13	PADZZ	5999-484-5513	7717-18N	13103	INSULATOR, DISK	EA	1

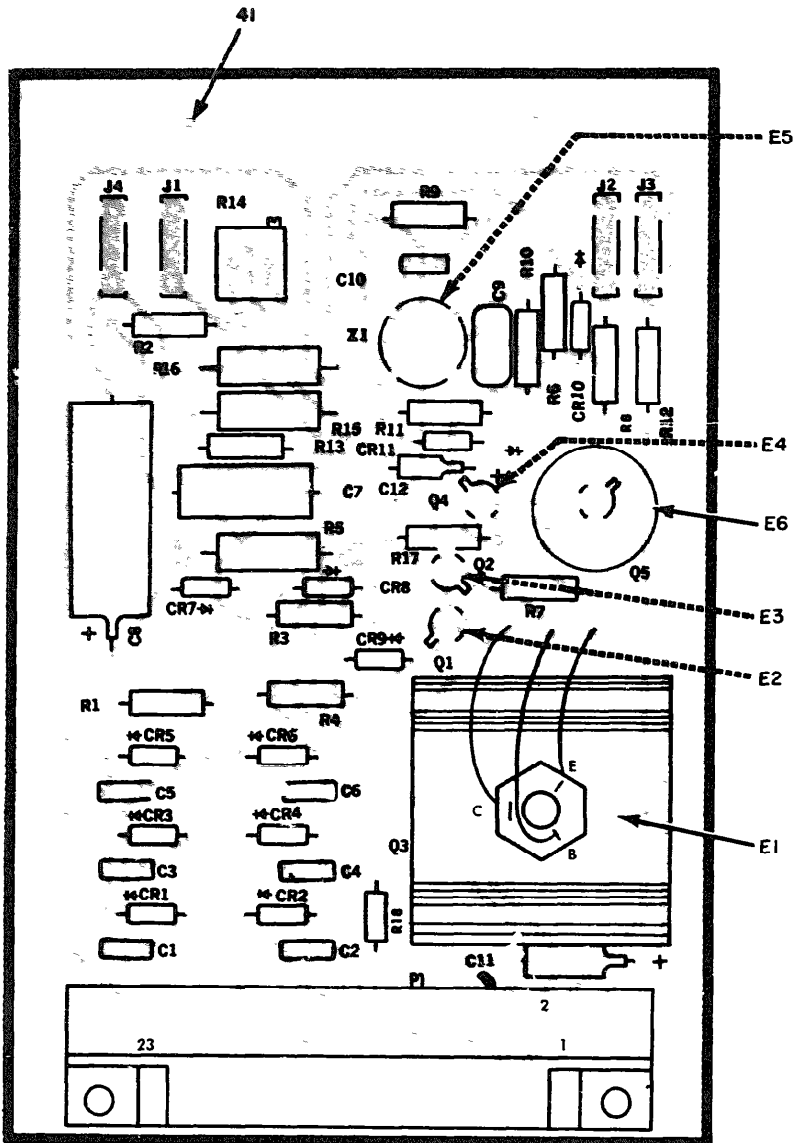

REF DES.	ITEM NO.	REF DES.	ITEM NO.	REF DES.	ITEM NO.	REF DES.	ITEM NO.
C1	1	CR4	8	J2	17	P7	31
C2	1	CR5	8	J3	18	R8	26
C3	1	CR6	8	J4	19	R9	27
C4	1	CR7	9	P1	20	R10	32
C5	1	CR8	9	Q1	21	R11	33
C6	1	CR9	10	Q2	22	R12	26
C7	2	CR10	10	Q3	23	R13	34
C8	3	CR11	11	Q4	21	R14	35
C9	4	E1	12	Q5	24	R15	36
C10	5	E2	13	R1	25	R16	37
C11	6	E3	13	R2	26	R17	38
C12	7	E4	13	R3	27	R18	39
CR1	8	E5	14	R4	28	Z1	40
CR2	8	E6	15	R5	29		
CR3	8	J1	16	R6	30		

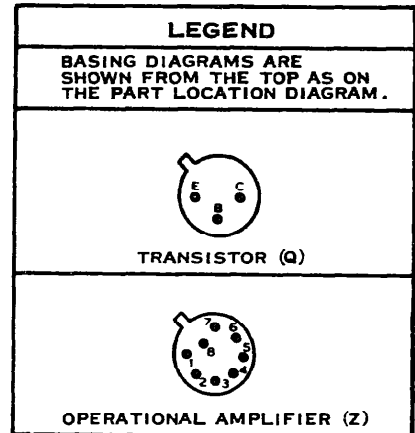

- NOTE:
1. LIGHT SHADING INDICATES ETCHED SIDE CIRCUIT PATTERN-DARK SHADING INDICATES COMPONENT SIDE PATTERN.
 2. FOR COMPLETE REFERENCE DESIGNATION PREFIX WITH 1A1A2
 3. E1 AND E6 ARE HEATSINKS, E2 THROUGH E5 ARE INSULATOR DISCS, ALL ARE MOUNTED UNDER THE COMPONENTS AS INDICATED

EL6625-1824-40P-TM-5

Figure 5 Power supply, Ic

SECTION II REPAIR PARTS LIST (CONTINUED)

(1) ILLUSTRATION		(2) SMR CODE	(3) FEDERAL STOCK NUMBER	(4) PART NUMBER	(5) FSCM	(6) DESCRIPTION	(7) UNIT OF MEAS	(8) QTY INC IN UNIT
(A) FIG NO.	(B) ITEM NO.							
6	14	PADZZ	5961-054-0339	7717-19DAP	13103	INSULATOR, DISK	EA	2
6	15	XBEZZ	5961-799-5539	2209-4A	13103	HEAT SINK, ELECTRICAL	EA	2
6	16	PADZZ	5935-131-9726	M39024-11-06	81349	JACK, TIP	EA	1
6	17	PADZZ	5935-823-0639	UPCCS2M23AACV	97954	CONNECTOR, RECEPTACLE, ELECTRICAL	EA	1
6	18	PADZZ	5961-925-3777	2N2907A	81349	TRANSISTOR	EA	1
6	19	PADZZ	5961-226-8579	2N940	81349	TRANSISTOR	EA	2
6	20	PADZZ	5961-951-8757	2N2922A	81349	TRANSISTOR	EA	2
6	21	PADZZ	5961-022-5670	2N2439	81349	TRANSISTOR	EA	2
6	22	PADZZ	5905-945-7053	RW70110R0F	81349	RESISTOR, FIXED, WIREWOUND	EA	4
6	23	PADZZ	5905-138-1285	RN60D2001F	81349	RESISTOR, FIXED, FILM	EA	2
6	24	PADZZ	5905-225-9390	RN60D7503F	81349	RESISTOR, FIXED, FILM	EA	1
6	25	PADZZ	5905-432-0468	RN60D3923F	81349	RESISTOR, FIXED, FILM	EA	1
6	26	PADZZ	5905-189-2472	RN60D4322F	81349	RESISTOR, FIXED, FILM	EA	1
6	27	PADZZ	5905-721-2385	RN60D3322F	81349	RESISTOR, FIXED, FILM	EA	2
6	28	PADZZ	5905-758-4840	RN60D1001F	81349	RESISTOR, FIXED, FILM	EA	1
6	29	PADZZ	5905-432-6410	RN60D1001F	81349	RESISTOR, FIXED, FILM	EA	3
6	30	PADZZ	5905-983-6914	RN60D1002F	81349	RESISTOR, FIXED, FILM	EA	1
6	31	PADZZ	5905-988-2313	RN60D1211F	81349	RESISTOR, FIXED, FILM	EA	1
6	32	PADZZ	5905-194-1695	RN60D4751F	81349	RESISTOR, FIXED, FILM	EA	2
6	33	PADZZ	5905-197-3172	RN60D2742F	81349	RESISTOR, FIXED, FILM	EA	1
6	34	PADZZ	5905-998-9178	PT24C2P202	81349	RESISTOR, VARIABLE, WIREWOUND	EA	1
6	35	PADZZ	5905-403-3147	RN60C4751F	81349	RESISTOR, FIXED, FILM	EA	1
6	36	PAI Z	5905-208-3800	RN60D4752F	81349	RESISTOR, FIXED, FILM	EA	1
6	37	PADZZ	5962-148-2858	S452709L	01295	INTEGRATED CIRCUIT, OPERATIONAL AMPLIFIER	EA	1
						GROUP 1A1AS FILAMENT SUPPLY, STORAGE TUBE		
7	1	PADZZ	5910-113-5540	CK14B4104F	81349	CAPACITOR, FIXED, CERAMIC DIELECTRIC	EA	2
7	2	PADZZ	5910-172-1381	CL65BE271MPE	81349	CAPACITOR, FIXED, ELECTROLYTIC	EA	1
7	3	PADZZ	5910-822-5683	CK63AW1021	81349	CAPACITOR, FIXED, CERAMIC DIELECTRIC	EA	1
7	4	PADZZ	5961-957-6865	1N3411	81349	SEMICONDUCTOR DEVICE, DIODE	EA	6
7	5	PADZZ	5961-836-6667	1N814	81349	SEMICONDUCTOR DEVICE, DIODE	EA	3
7	6	PADZZ	5961-842-9864	1N914	81349	SEMICONDUCTOR DEVICE, DIODE	EA	1
7	7	PADZZ	5961-995-2310	1N752A	81349	SEMICONDUCTOR DEVICE, DIODE	EA	1
7	8	PADZZ	5961-734-1105	A10067DAP	97047	INSULATOR, DISK	EA	3
7	9	PADZZ	5935-131-9696	M39024-11-04	81349	JACK, TIP	EA	1
7	10	PADZZ	5935-131-9681	M39024-11-02	81349	JACK, TIP	EA	1
7	11	PADZZ	5935-131-9726	M39024-11-06	81349	JACK, TIP	EA	1
7	12	PADZZ	5935-243-8510	UPCCS2M23AACF	97954	CONNECTOR, RECEPTACLE, ELECTRICAL	EA	1
7	13	PADZZ	5961-913-1747	2N2907	81349	TRANSISTOR	EA	1
7	14	PADZZ	5961-951-8757	2N2922A	81349	TRANSISTOR	EA	2
7	15	PADZZ	5905-051-5557	RW69VR47	81349	RESISTOR, FIXED, WIREWOUND	EA	1
7	16	PADZZ	5905-452-0768	RN60D6191F	81349	RESISTOR, FIXED, FILM	EA	1
7	17	PADZZ	5905-983-6914	RN60D1002F	81349	RESISTOR, FIXED, FILM	EA	4
7	18	PADZZ	5905-957-8633	RN60D51R1F	81349	RESISTOR, FIXED, FILM	EA	1

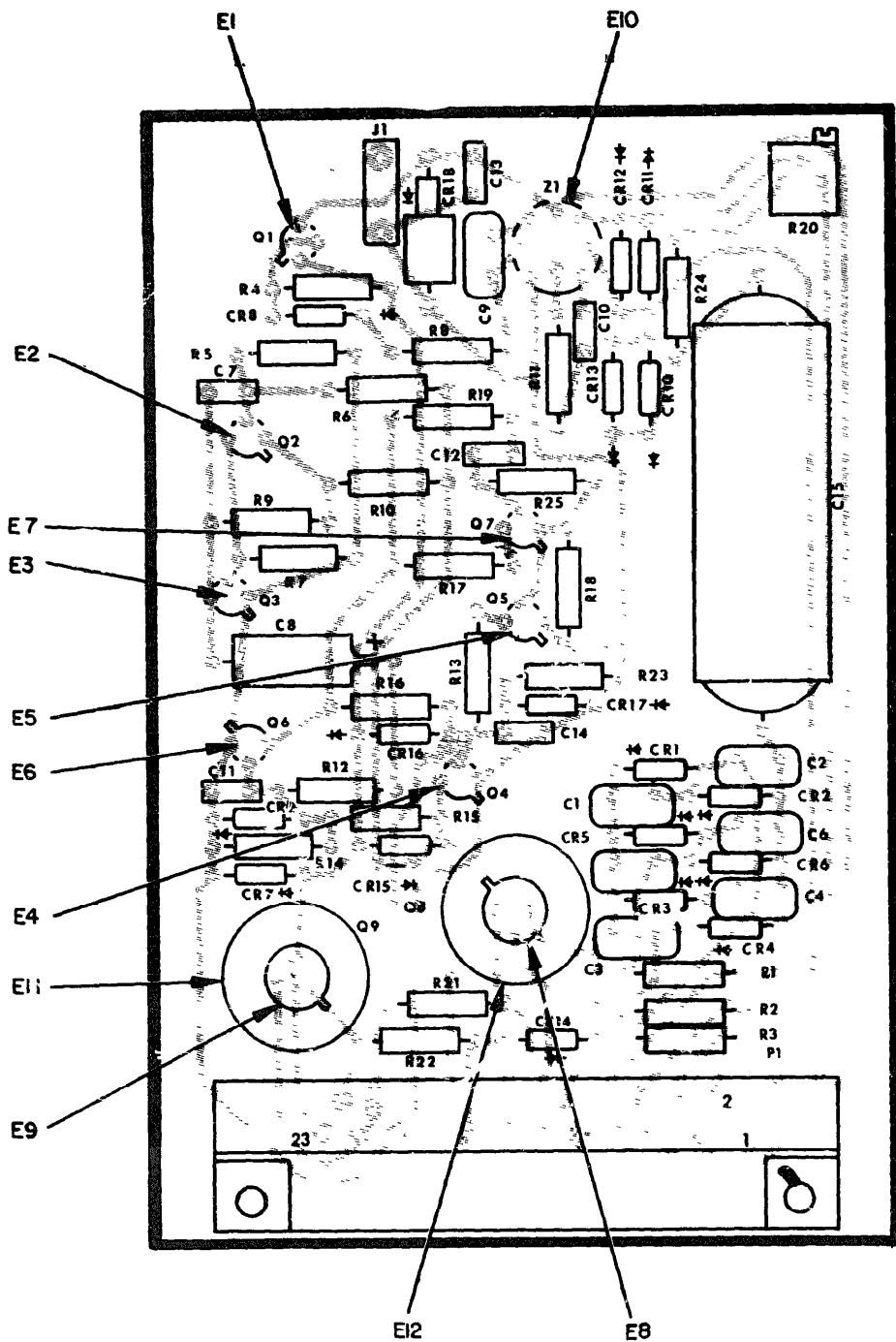

REF. DES. NO.	REF. DES. NO.	REF. DES. NO.	REF. DES. NO.	REF. DES. NO.	REF. DES. NO.
C1 1	CR6 8	E8 13	R5 24	R25 38	Z1 37
C2 1	CR7 9	E9 13	R6 25		
C3 1	CR8 9	E10 14	R7 26		
C4 1	CR9 10	E11 15	R8 23		
C5 1	CR10 11	E12 15	R9 27		
C6 1	CR11 10	J1 16	R10 27		
C7 2	CR12 10	PI 17	R11 28		
C8 3	CR13 10	Q1 18	R12 29		
C9 4	CR14 8	Q2 19	R13 22		
C10 5	CR15 8	Q3 18	R14 30		
C11 6	CR16 9	Q4 20	R15 30		
C12 2	CR17 10	Q5 20	R16 31		
C13 6	CR18 12	Q6 18	R17 32		
C14 6	E1 13	Q7 19	R18 32		
C15 7	E2 13	Q8 21	R19 33		
CR1 8	E3 13	Q9 21	R20 34		
CR2 8	E4 13	R1 22	R21 29		
CR3 8	E5 13	R2 22	R22 29		
CR4 8	E6 13	R3 22	R23 23		
CR5 8	E7 13	R4 23	R24 35		

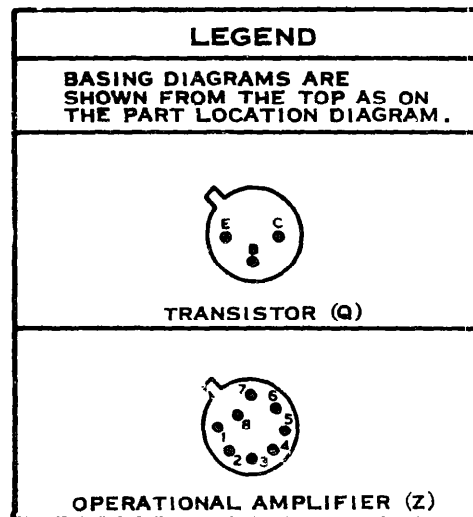

NOTES:

1. LIGHT SHADING INDICATES ETCHED SIDE CIRCUIT PATTERN - DARK SHADING INDICATES COMPONENT SIDE PATTERN
2. FOR COMPLETE REFERENCE DESIGNATION PREFIX WITH IAIA3 OR IAIA4
3. E1 THROUGH E10 ARE MOUNTED UNDER DESIGNATED COMPONENTS, E11 AND E12 ARE HEATSINKS LOCATED UNDER Q8 AND Q9.

EL6625-1824-40P-TM-6

Figure 6 Power supply, +150/250 Vdc

SECTION II REPAIR PARTS LIST (CONTINUED)

(1) ILLUSTRATION		(2) SMR CODE	(3) FEDERAL STOCK NUMBER	(4) PART NUMBER	(5) FSCM	(6) DESCRIPTION	(7) UNIT OF MEAS	(8) QTY INC IN UNIT
(A) FIG NO.	(B) ITEM NO.							
6	19	PADZZ	5905-989-9362	RN65F2430F	81349	RESISTOR, FIXED, WIREWOUND	EA	1
7	20	PADZZ	5905-424-9312	RT22C2P502	81349	RESISTOR, VARIABLE, WIREWOUND	EA	1
7	21	PADZZ	5905-455-0809	RN65C8250F	81349	RESISTOR, FIXED, FILM	EA	1
GROUP IA1A6 POWER CONTROL, TC1 and CS-VC								
8	1	PADZZ	5910-936-1832	CSR13F685KL	81349	CAPACITOR, FIXED, ELECTROLYTIC	EA	2
8	2	PADZZ	5910-010-8718	CK06BY103K	81349	CAPACITOR, FIXED, CERAMIC DIELECTRIC	EA	2
8	3	PADZZ	5910-495-0042	CSR13G105KL	81349	CAPACITOR, FIXED, ELECTROLYTIC	EA	1
8	4	PADZZ	5910-143-0501	CK06BY472K	81349	CAPACITOR, FIXED, CERAMIC DIELECTRIC	EA	1
8	5	PADZZ	5910-453-8796	CM05FD181J03	81349	CAPACITOR, FIXED, MICA DIELECTRIC	EA	1
8	6	PADZZ	5961-894-0684	1N758A	81349	SEMICONDUCTOR DEVICE, DIODE	EA	1
8	7	PADZZ	5961-950-9887	1N827	81349	SEMICONDUCTOR DEVICE, DIODE	EA	1
8	8	PADZZ	5961-842-9864	1N914	81349	SEMICONDUCTOR DEVICE, DIODE	EA	2
8	9	PADZZ	5961-054-0339	7717-19DAP	13103	INSULATOR, DISK	EA	3
8	10	PADZZ	5961-4919-4224	7717-44N	13103	INSULATOR, DISK	EA	2
8	11	XBHFF	5961-951-5474	10105DAP	07047	INSULATOR, PLATE	EA	2
8	12	PADZZ	5935-131-9696	M39024-11-04	81349	JACK, TIP	EA	1
8	13	PADZZ	5935-131-9681	M39024-11-07	81349	JACK, TIP	EA	1
8	14	PADZZ	5935-131-9726	M39024-11-06	81349	JACK, TIP	EA	1
8	15	PADZZ	5945-478-7662	EA1B131	35344	RELAY, ARMATURE	EA	1
8	16	PADZZ	5945-406-3076	EA1A124	35344	RELAY, ARMATURE	EA	1
8	17	PADZZ	5935-689-1888	JPCGSGM23AABR	97954	CONNECTOR, RECEPTACLE, ELECTRICAL	EA	1
8	18	PADZZ	5961-951-8757	2N222A	81349	TRANSISTOR	EA	2
8	19	PADZZ	5905-496-5253	RN65F2430F	81349	RESISTOR, FIXED, FILM	EA	1
8	20	PADZZ	5905-926-8630	RL32S240J	81349	RESISTOR, FIXED, FILM	EA	2
8	21	PADZZ	5905-004-6103	RN65C3830F	81349	RESISTOR, FIXED, FILM	EA	1
8	22	PADZZ	5905-153-0135	RN55C1212F	81349	RESISTOR, FIXED, FILM	EA	2
8	23	PADZZ	5905-477-9176	RN55C2001F	81349	RESISTOR, FIXED, FILM	EA	1
8	24	PADZZ	5905-025-5984	RN65C1473F	81349	RESISTOR, FIXED, FILM	EA	1
8	25	PADZZ	5905-122-1233	RN55C3011F	81349	RESISTOR, FIXED, FILM	EA	5
8	26	PADZZ	5905-223-2741	RN55C1002F	81349	RESISTOR, FIXED, FILM	EA	9
8	27	PADZZ	5905-480-5196	RN55C1501F	81349	RESISTOR, FIXED, FILM	EA	1
8	28	PADZZ	5905-067-7338	RT22C2P502	81349	RESISTOR, VARIABLE, WIREWOUND	EA	2
8	29	PADZZ	5905-121-6327	RN55C4321F	81349	RESISTOR, FIXED, FILM	EA	1
8	30	PADZZ	5905-256-5051	RN55C5621F	81349	RESISTOR, FIXED, FILM	EA	1
8	31	PADZZ	5905-412-4049	RN55C4751F	81349	RESISTOR, FIXED, FILM	EA	1
8	32	PADZZ	5905-947-5641	RN65F2494F	81349	RESISTOR, FIXED, FILM	EA	1
8	33	PADZZ	5962-148-2858	SN52709L	01295	INTEGRATED CIRCUIT, OPERATIONAL AMPLIFIER	EA	3
GROUP IA1A7 SIMULATOR, CS-VC								
9	1	PADZZ	5910-902-0031	CM05CDO50D03	81349	CAPACITOR, FIXED, MICA DIELECTRIC	EA	1
9	2	PADZZ	5910-835-2734	CTM104VAJ	81349	CAPACITOR, FIXED, PLASTIC DIELECTRIC	EA	1
9	3	PADZZ	5910-410-9329	CM05FD102J03	81349	CAPACITOR, FIXED, MICA DIELECTRIC	EA	1
9	4	PADZZ	5910-112-4337	CK05BX100K	81349	CAPACITOR, FIXED, CERAMIC DIELECTRIC	EA	1
9	5	PADZZ	5910-113-5445	CK05BX221K	81349	CAPACITOR, FIXED, CERAMIC DIELECTRIC	EA	1

NOTE :

1. LIGHT SHADING INDICATES ETCHED SIDE
CIRCUIT PATTERN-DARK SHADING INDICATES
COMPONENT SIDE PATTERN.
2. FOR COMPLETE REFERENCE DESIGNATION
PREFIX WITH 1A1A5.
3. E1, E2, AND E3 ARE INSULATOR DISKS MOUNTED
UNDER Q1, Q2, AND Q3 AS INDICATED.

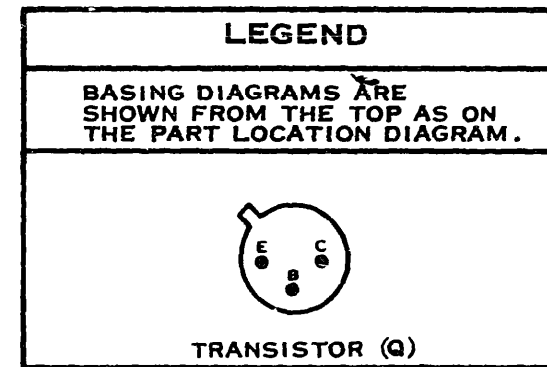
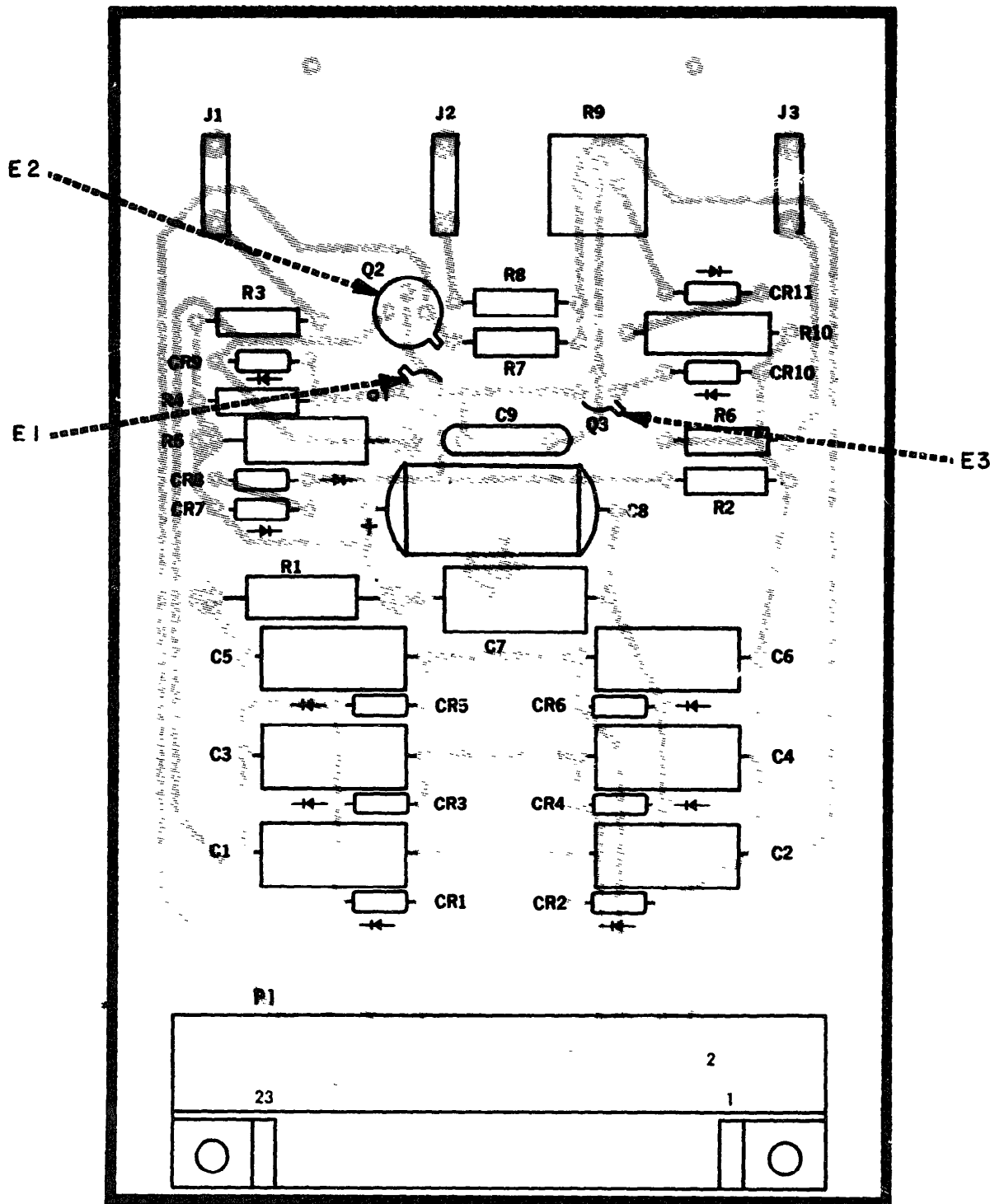

REF DES	ITEM NO	REF DES	ITEM NO	REF DES	ITEM NO	REF DES	ITEM NO
C1	1	CR2	4	E1	8	R1	15
C2	1	CR3	4	E2	8	R2	16
C3	1	CR4	4	E3	8	R3	17
C4	1	CR5	4	J1	9	R4	18
C5	1	CR6	4	J2	10	R5	19
C6	1	CR7	5	J3	11	R6	17
C7	1	CR8	5	P1	12	R7	17
C8	2	CR9	6	Q1	13	R8	17
C9	3	CR10	7	Q2	14	R9	20
CR1	4	CR11	5	Q3	14	R10	21

Figure 7 Filament supply, storage tube

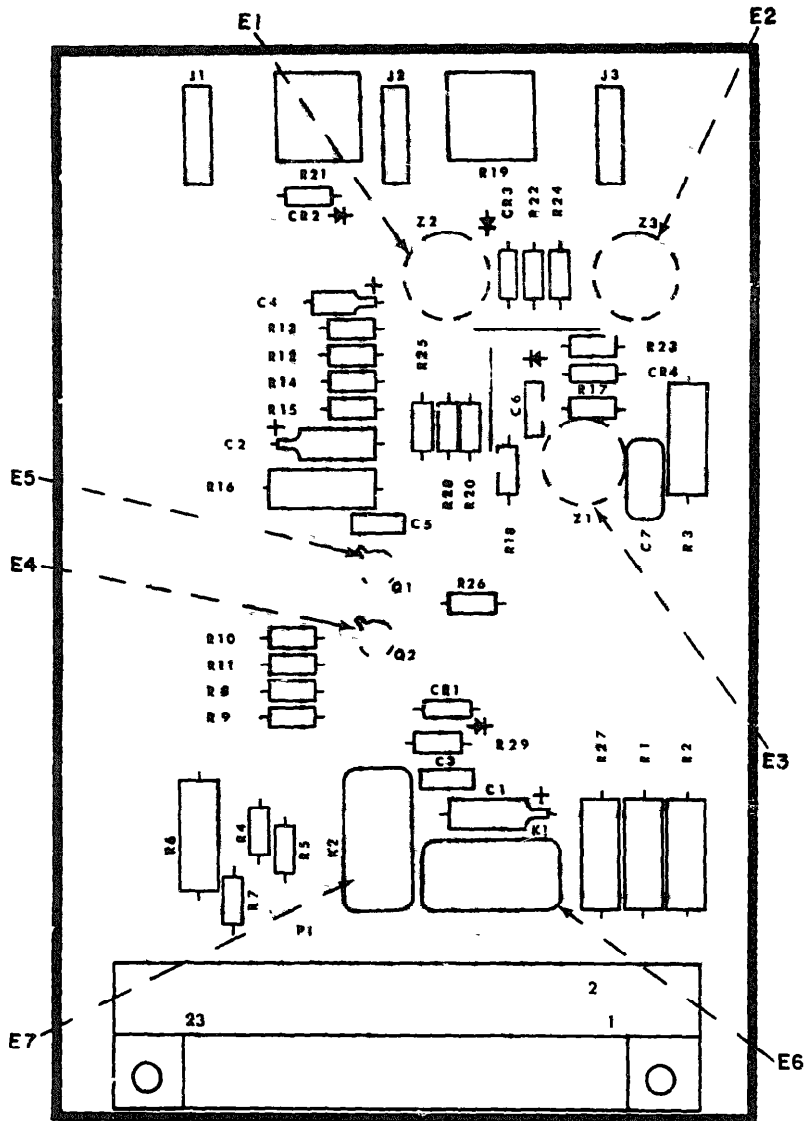

REF. DES.	ITEM NO.	REF. DES.	ITEM NO.
C1	1	R5	23
C2	1	R6	24
C3	2	R7	22
C4	3	R8	25
C5	2	R9	25
C6	4	R10	25
C7	5	R11	25
CR1	6	R12	26
CR2	7	R13	26
CR3	8	R14	26
CR4	8	R15	26
E1	9	R16	20
E2	9	R17	27
E3	9	R18	26
E4	10	R19	28
E5	10	R20	26
E6	11	R21	28
E7	11	R22	26
J1	12	R23	26
J2	13	R24	29
J3	14	R25	30
K1	15	R26	31
K2	16	R27	32
P1	17	R28	26
Q1	18	R29	25
Q2	18	Z1	33
R1	19	Z2	33
R2	20	Z3	33
R3	21		
R4	22		

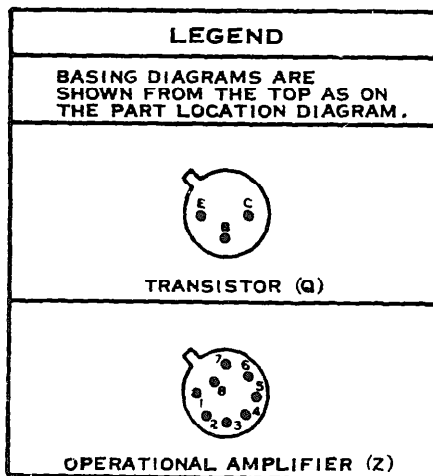

NOTE:

1. BASING DIAGRAMS FOR RELAYS ARE ILLUSTRATED ON THE RELAY CASE.
2. LIGHT SHADING INDICATES ETCHED SIDE CIRCUIT PATTERN—DARK SHADING INDICATES COMPONENT SIDE PATTERN.
3. FOR COMPLETE REFERENCE DESIGNATION PREFIX WITH IAIA6
4. E1 THROUGH E7 ARE INSULATOR DISKS LOCATED UNDER THE COMPONENTS AS INDICATED.

EL6625-1824-40P-TM-8

Figure 8 Power control, TCI and Cs- Vc

SECTION II REPAIR PARTS LIST (CONTINUED)

(1) ILLUSTRATION		(2) SMR CODE	(3) FEDERAL STOCK NUMBER	(4) PART NUMBER	(5) FSCM	(6) DESCRIPTION	(7) UNIT OF MEAS	(8) QTY INC IN UNIT
(A) FIG NO.	(B) ITEM NO.							
9	6	PADZZ	5910-113-5276	CK05BK471K	81349	CAPACITOR, FIXED, CERAMIC DIELECTRIC	EA	2
9	7	PADZZ	5961-821-2309	1N751A	81349	SEMICONDUCTOR DEVICE, DIODE	EA	1
9	8	PADZZ	5961-842-9864	1N914	81349	SEMICONDUCTOR DEVICE, DIODE	EA	2
9	9	PADZZ	5999-484-5513	7717-18H	13103	INSULATOR, DISK	EA	2
9	10	PADZZ	5950-921-4074	MS30337-23	96906	COIL, RADIO FREQUENCY	EA	1
9	11	PADZZ	6625-409-8162	UPCCSGM23AAEJ	97954	CONNECTOR, RECEPTACLE, ELECTRICAL	EA	1
9	12	PADZZ	5961-951-8757	2N2222A	81349	TRANSISTOR	EA	6
9	13	PADZZ	5961-925-3777	2N2907A	81349	TRANSISTOR	EA	1
9	14	PADZZ	5961-761-4504	2N4949	81349	TRANSISTOR	EA	1
9	15	PADZZ	5905-137-0804	RN60D1003F	81349	RESISTOR, FIXED, FILM	EA	1
9	16	PADZZ	5905-243-9030	RW70U2210F	81349	RESISTOR, FIXED, WIREWOUND	EA	1
9	17	PADZZ	5905-227-5072	RN60D3920F	81349	RESISTOR, FIXED, FILM	EA	1
9	18	PADZZ	5905-988-2310	RN60D1000F	81349	RESISTOR, FIXED, FILM	EA	2
9	19	PADZZ	5905-078-8365	RN60D5112F	81349	RESISTOR, FIXED, FILM	EA	1
9	20	PADZZ	5905-997-2182	RT11C2P502	81349	RESISTOR, VARIABLE, WIREWOUND	EA	1
9	21	PADZZ	5905-721-2387	RN60D6190F	81349	RESISTOR, FIXED, FILM	EA	1
9	22	PADZZ	5905-192-3889	RN60D2492F	81349	RESISTOR, FIXED, FILM	EA	1
9	23	PADZZ	5905-432-6410	RN60D1001F	81349	RESISTOR, FIXED, FILM	EA	2
9	24	PADZZ	5905-758-4840	RN60D1501F	81349	RESISTOR, FIXED, FILM	EA	2
9	25	PADZZ	5905-195-6384	RN60D3012F	81349	RESISTOR, FIXED, FILM	EA	2
9	26	PADZZ	5905-983-6914	RN60D1002F	81349	RESISTOR, FIXED, FILM	EA	1
9	27	PADZZ	5905-079-3500	RT11C2P101	81349	RESISTOR, VARIABLE, WIREWOUND	EA	1
9	28	PADZZ	5962-247-3392	SN5440J	01295	INTEGRATED CIRCUIT, INPUT BUFFER	EA	1
9	29	PADZZ	5962-245-1616	SN5473J	01295	INTEGRATED CIRCUIT, FLIP-FLOP	EA	5
9	30	PADZZ	5962-245-1612	SN5410J	01295	INTEGRATED CIRCUIT, INPUT GATE	EA	1
GROUP 1A1A8 VIDEO INTERFACE								
10	1	PADZZ	5910-777-6919	CM07FD103J03	81349	CAPACITOR, FIXED, MICA DIELECTRIC	EA	4
10	2	PADZZ	5910-010-8718	CK06BX103K	81349	CAPACITOR, FIXED, CERAMIC DIELECTRIC	EA	8
10	3	PADZZ	5910-490-0397	CM05FD470J03	81349	CAPACITOR, FIXED, MICA DIELECTRIC	EA	2
10	4	PADZZ	5910-954-1769	CM05FD151J03	81349	CAPACITOR, FIXED, MICA DIELECTRIC	EA	2
10	5	PADZZ	5961-846-9157	1N759A	81349	SEMICONDUCTOR DEVICE, DIODE	EA	1
10	6	PADZZ	5961-752-6121	1N753A	81349	SEMICONDUCTOR DEVICE, DIODE	EA	1
10	7	PADZZ	5961-054-0339	7717-19DAP	13103	INSULATOR, DISK	EA	4
10	8	XBHFF	5961-951-5474	1015DAP	07047	INSULATOR, PLATE	EA	2
10	9	PADZZ	5945-406-3076	EAL1A124	35344	RELAY, ARMATURE	EA	1
10	10	PADZZ	5945-851-2878	EAL1A055	35344	RELAY, ARMATURE	EA	1
10	11	PADZZ	5935-131-9696	M39024-11-04	81349	JACK, TIP	EA	1
10	12	PADZZ	5935-131-9681	M39024-11-02	81349	JACK, TIP	EA	1
10	13	PADZZ		UPCCSGM23AAEJ	97954	CONNECTOR, RECEPTACLE, ELECTRICAL	EA	1
10	14	PADZZ	5905-142-0901	RN60D2000F	81349	RESISTOR, FIXED, FILM	EA	1
10	15	PADZZ	5905-189-2474	RN60D4750F	81349	RESISTOR, FIXED, FILM	EA	1
10	16	PADZZ	5905-957-8633	RN60D51R1F	81349	RESISTOR, FIXED, FILM	EA	4
10	17	PADZZ	5905-914-9254	RN60D231F	81349	RESISTOR, FIXED, FILM	EA	6

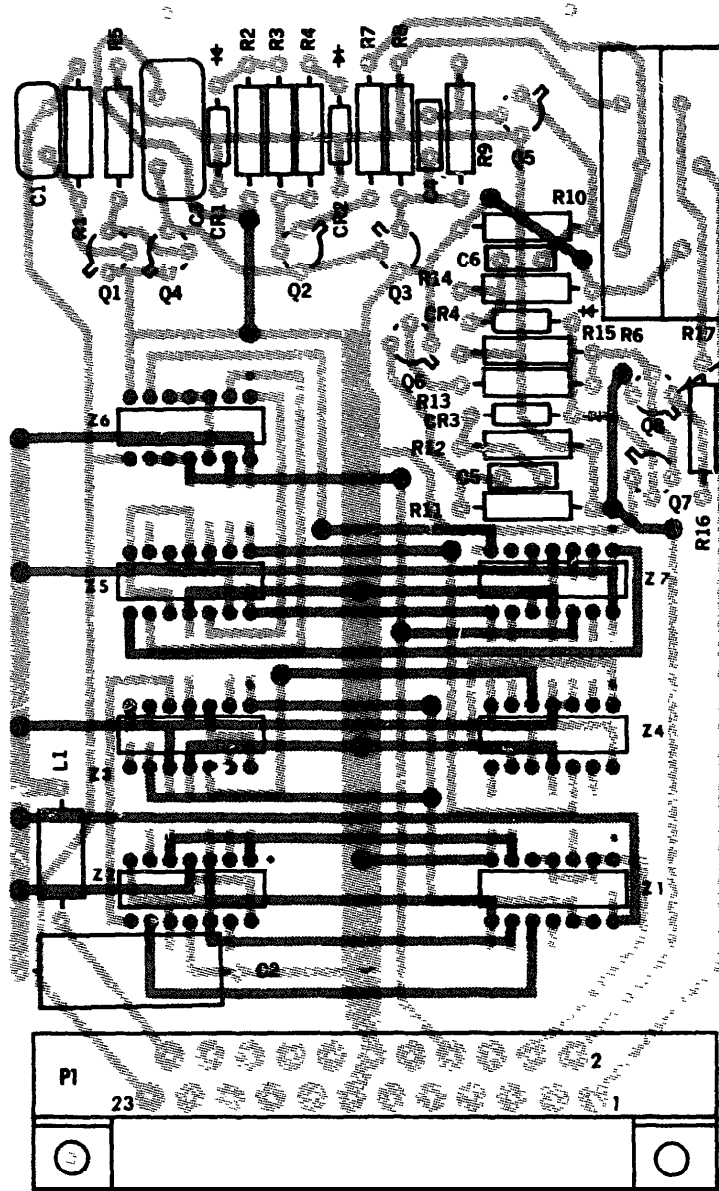

NOTE :

1. LIGHT SHADING INDICATES ETCHED SIDE
CIRCUIT PATTERN-DARK SHADING INDICATES
COMPONENT SIDE PATTERN.
2. FOR COMPLETE REFERENCE DESIGNATION
PREFIX WITH 1A1A7
3. EACH TRANSISTOR (Q1 THROUGH Q8) IS MOUNTED
ON AN INSULATOR DISK (EI THROUGH E8)

SEE NOTE 3

LEGEND

BASING DIAGRAMS ARE
SHOWN FROM THE TOP AS ON
THE PART LOCATION DIAGRAM.

TRANSISTOR (Q)

INTEGRATED CIRCUIT
14-PIN DUAL-INLINE (Z)

UNIUNCTION TRANSISTOR (Q)

REF DES	ITEM NO	REF DES	ITEM NO
C1	1	Q7	12
C2	2	Q8	12
C3	3	R1	15
C4	4	R2	16
C5	5	R3	17
C6	6	R4	18
CR1	7	R5	19
CR2	8	R6	20
CR3	8	R7	19
CR4	8	R8	21
E1	9	R9	22
E2	9	R10	23
E3	9	R11	24
E4	9	R12	25
E5	9	R13	25
E6	9	R14	26
E7	9	R15	24
E8	9	R16	23
L1	10	R17	27
P1	11	Z1	28
Q1	12	Z2	29
Q2	13	Z3	29
Q3	14	Z4	29
Q4	12	Z5	29
Q5	12	Z6	30
Q6	12	Z7	29

Figure 9 Simulator, Cs-Vc

SECTION II REPAIR PARTS LIST (CONTINUED)

(1) ILLUSTRATION		(2) SMR CODE	(3) FEDERAL STOCK NUMBER	(4) PART NUMBER	(5) FSCM	(6) DESCRIPTION	(7) UNIT OF MEAS
(A) FIG NO.	(B) ITEM NO.						
10	18	PADZZ	5905-702-9485	RN60D22P1F	81349	RESISTOR, FIXED, FILM	EA
10	19	PADZZ	5905-195-6384	RN60D3012F	81349	RESISTOR, FIXED, FILM	EA
10	20	PADZZ	5905-983-6914	RN60D1002F	81349	RESISTOR, FIXED, FILM	EA
10	21	PADZZ	5905-138-1285	RN60D2001F	81349	RESISTOR, FIXED, FILM	EA
10	22	PADZZ	5905-451-7534	RN60D7500F	81349	RESISTOR, FIXED, FILM	EA
10	23	PADZZ	5905-758-2063	RN60D2210F	81349	RESISTOR, FIXED, FILM	EA
10	24	PADZZ	5905-432-6410	RN60D1001F	81349	RESISTOR, FIXED, FILM	EA
10	25	PADZZ	5962-245-5325	SN52702L	01295	INTEGRATED CIRCUIT, OPERATIONAL AMPLIFIER	EA
GROUP 1A1A9 SYNCHRONOUS INTERFACE							
11	1	PADZZ	5910-010-8718	CK06BX103K	81349	CAPACITOR, FIXED CERAMIC DIELECTRIC	EA
11	2	PADZZ	5910-143-0501	CK06BX472K	81349	CAPACITOR, FIXED, CERAMIC DIELECTRIC	EA
11	3	PADZZ	5910-460-0869	CM05FD221J03	81349	CAPACITOR, FIXED, MICA DIELECTRIC	EA
11	4	PADZZ	5961-752-6121	1N753A	81349	SEMICONDUCTOR DEVICE, DIODE	EA
11	5	PADZZ	5961-846-9157	1N759A	81349	SEMICONDUCTOR DEVICE, DIODE	EA
11	6	PADZZ	5961-054-0339	7717-19DAP	13103	INSULATOR, DISK	EA
11	7	PADZZ	5999-484-5513	7717-18N	13103	INSULATOR, DISK	EA
11	8	PADZZ	5935-236-7834	U7C3GM23AADL	97954	CONNECTOR, RECEPTACLE, ELECTRICAL	EA
11	9	PADZZ	5961-913-1747	2N2907	81349	TRANSISTOR	EA
11	10	PADZZ	5961-949-6563	2N2432	81349	TRANSISTOR	EA
11	11	PADZZ	5905-112-1661	RN60D4423F	81349	RESISTOR, FIXED, FILM	EA
11	12	PADZZ	5905-197-3172	RN60D2742F	81349	RESISTOR, FIXED, FILM	EA
11	13	PADZZ	5905-142-0901	RN60D2000F	81349	RESISTOR, FIXED, FILM	EA
11	14	PADZZ	5905-432-6410	RN60D1001F	81349	RESISTOR, FIXED, FILM	EA
11	15	PADZZ	5905-988-2310	RN60D1000F	81349	RESISTOR, FIXED, FILM	EA
11	16	PADZZ	5905-189-2474	RN60D4750F	81349	RESISTOR, FIXED, FILM	EA
11	17	PADZZ	5905-189-2456	RN60D1103F	81349	RESISTOR, FIXED, FILM	EA
11	18	PADZZ	5905-892-6578	RN60D1212F	81349	RESISTOR, FIXED, FILM	EA
11	19	PADZZ	5905-452-0756	RN60D4221F	81349	RESISTOR, FIXED, FILM	EA
11	20	PADZZ	5905-138-1285	RN60D2001F	81349	RESISTOR, FIXED, FILM	EA
11	21	PADZZ	5905-983-6914	RN60D1002F	81349	RESISTOR, FIXED, FILM	EA
11	22	PADZZ	5905-195-6379	RN60D1822F	81349	RESISTOR, FIXED, FILM	EA
11	23	PADZZ	5905-192-3479	RN60D9091F	81349	RESISTOR, FIXED, FILM	EA
11	24	PADZZ	5905-758-4840	RN60D1501F	81349	RESISTOR, FIXED, FILM	EA
11	25	PADZZ	5905-721-2385	RN60D3322F	81349	RESISTOR, FIXED, FILM	EA
11	26	PADZZ	5962-248-2336	SN52710L	01295	INTEGRATED CIRCUIT, DIFFERENTIATING COMPARATOR	EA
11	27	PADZZ	5962-411-6306	SN5400-5	01295	INTEGRATED CIRCUIT, INPUT GATE	EA
11	28	PADZZ	5962-148-2858	SN52709L	01295	INTEGRATED CIRCUIT, OPERATIONAL AMPLIFIER	EA
GROUP 1A1A10 GENERATOR, ROT POT							
12	1	PADZZ	5910-154-0547	CSR13F476KL	81349	CAPACITOR, FIXED, ELECTROLYTIC	EA
12	2	PADZZ	5910-113-5689	CSR13E476KL	81349	CAPACITOR, FIXED, ELECTROLYTIC	EA
12	3	PADZZ	5910-456-9511	CM05FD272J03	81349	CAPACITOR, FIXED, MICA DIELECTRIC	EA
12	4	PADZZ	5910-410-9329	CM05FD102J03	81349	CAPACITOR, FIXED, MICA DIELECTRIC	EA

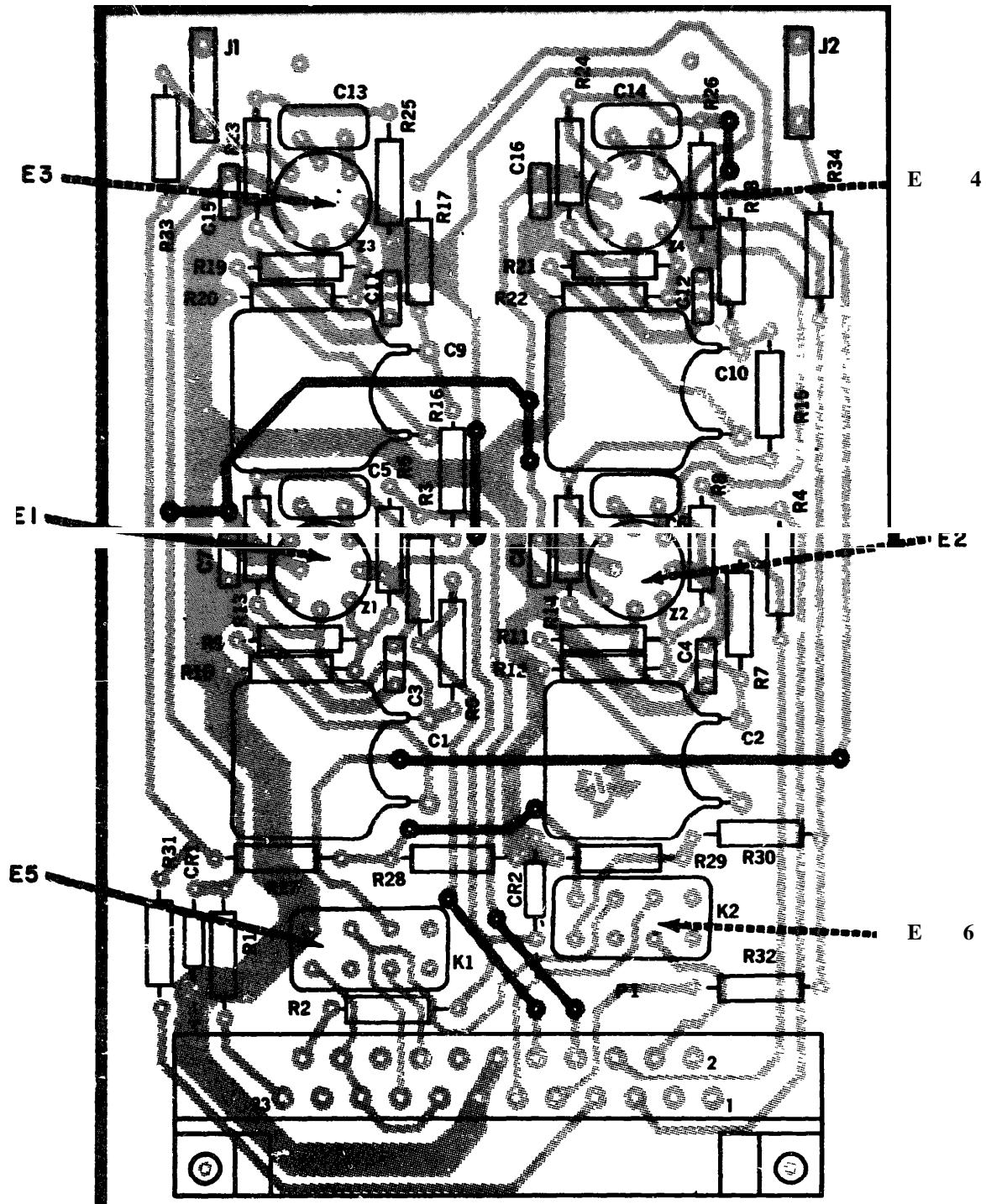

REF DES	ITEM NO	REF DES	ITEM NO	REF DES	ITEM NO	REF DES	ITEM NO	REF DES	ITEM NO
C1	1	C15	2	P1	13	R14	19	R28	16
C2	1	C16	2	R1	14	R15	20	R29	16
C3	2	CR1	5	R2	15	R16	20	R30	22
C4	2	CR2	6	R3	16	R17	20	R31	23
C5	3	E1	7	R4	16	R18	20	R32	23
C6	3	E2	7	R5	17	R19	18	R33	24
C7	2	E3	7	R6	17	R20	17	R34	24
C8	2	E4	7	R7	17	R21	18	Z1	25
C9	1	E5	8	R8	17	R22	17	Z2	25
C10	1	E6	8	R9	18	R23	20	Z3	25
C11	2	K1	9	R10	19	R24	20	Z4	25
C12	2	K2	10	R11	18	R25	21		
C13	4	J1	11	R12	19	R26	21		
C14	4	J2	12	R13	19	R27	22		

LEGEND

BASING DIAGRAMS ARE SHOWN FROM THE TOP AS ON THE PART LOCATION DIAGRAM.

OPERATIONAL AMPLIFIER (Z)

NOTE :

1. BASING DIAGRAMS FOR RELAYS ARE ILLUSTRATED ON THE RELAY CASE.
2. LIGHT SHADING INDICATES ETCHED SIDE CIRCUIT PATTERN-DARK SHADING INDICATES COMPONENT SIDE PATTERN.
3. FOR COMPLETE REFERENCE DESIGNATION PREFIX WITH 1A1A8
4. E1 THROUGH E6 ARE INSULATOR DISK MOUNTED UNDER THE COMPONENTS AS INDICATED.

Figure 10. Video Interface

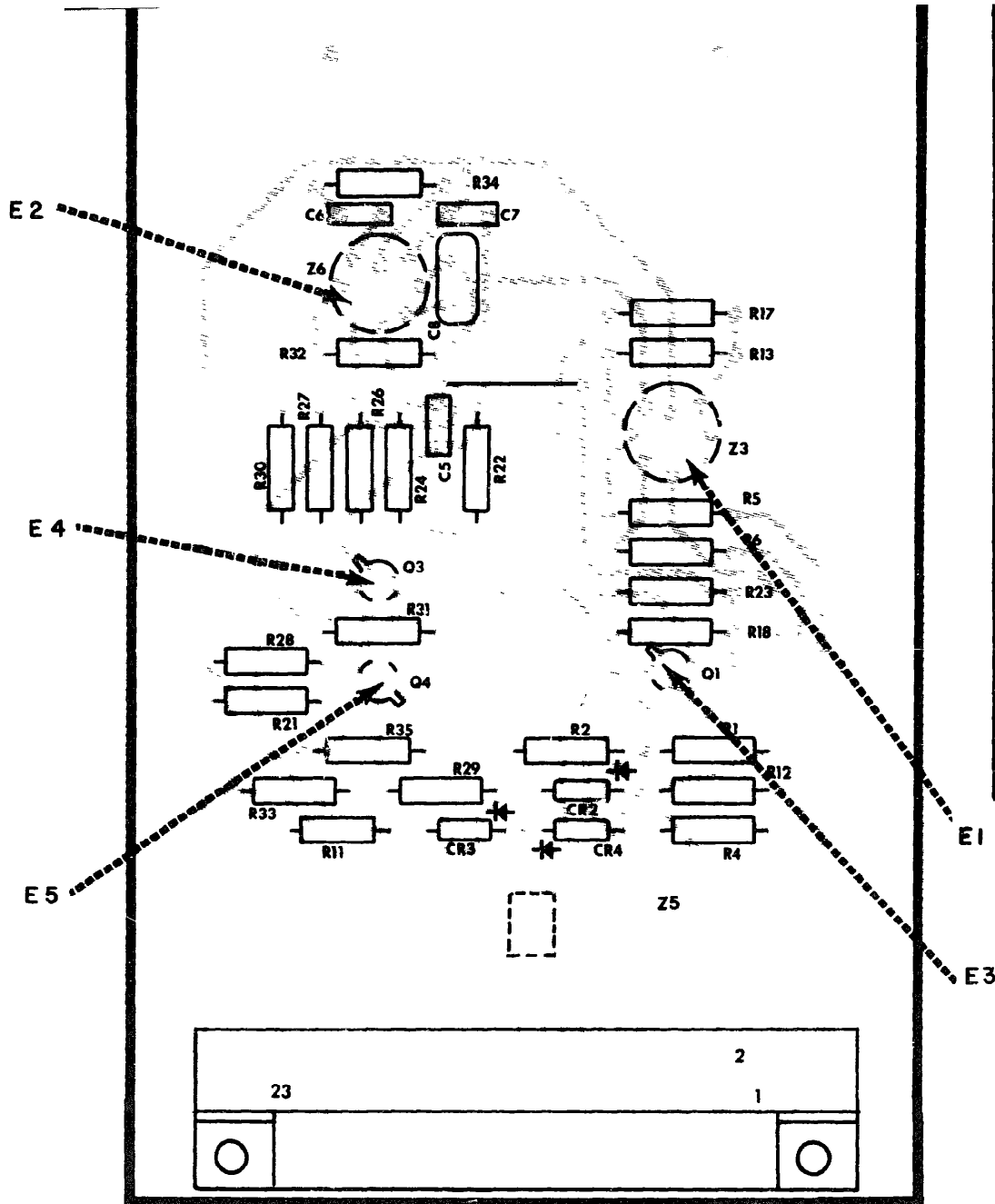

REF DES	ITEM NO	REF DES	ITEM NO
C5	1	R12	16
C6	2	R13	17
C7	1	R17	14
C8	3	R18	18
CR2	4	R21	19
CR3	5	R22	20
CR4	5	R23	20
E1	6	R24	21
E2	6	R26	22
E3	7	R27	23
E4	7	R28	21
E5	7	R29	19
PI	8	R30	21
Q1	9	R31	18
Q3	10	R32	17
Q4	10	R33	21
R1	11	R34	24
R2	12	R35	25
R4	13	Z3	26
R5	14	Z5	27
R6	14	Z6	28
R11	15		

LEGEND

BASING DIAGRAMS ARE SHOWN FROM THE TOP AS ON THE PART LOCATION DIAGRAM.

TRANSISTOR (Q)

OPERATIONAL AMPLIFIER (Z)

INTEGRATED CIRCUIT 14-PIN DUAL-INLINE (Z)

NOTE:

1. LIGHT SHADING INDICATES ETCHED SIDE CIRCUIT PATTERN-DARK SHADING INDICATES COMPONENT SIDE PATTERN.
2. FOR COMPLETE REFERENCE DESIGNATION PREFIX WITH 1A1A9
- 3 E1 THROUGH E5 ARE INSULATOR DISKS MOUNTED UNDER THE COMPONENTS AS INDICATED

Figure 11. Synchronous interface

SECTION II REPAIR PARTS LIST (CONTINUED)

(1) ILLUSTRATION		(2) SMR CODE	(3) FEDERAL STOCK NUMBER	(4) PART NUMBER	(5) FSCM	(6) DESCRIPTION	(7) UNIT OF MEAS	(8) QTY INC IN UNIT
(A) FIG NO.	(B) ITEM NO.							
12	5	PADZZ	5910-483-4387	CL23BJ100TNE	81349	CAPACITOR, FIXED, ELECTROLYTIC	EA	1
12	6	PADZZ	5961-842-9864	14914	81349	SEMICONDUCTOR DEVICE, DIODE	EA	2
12	7	PADZZ	5961-919-4224	7717-44N	13103	INSULATOR, DISK	EA	5
12	8	PADZZ		UPCCSGM23AACM	97954	CONNECTOR, RECEPTACLE, ELECTRICAL	EA	1
12	9	PADZZ	5961-951-8757	2N2222A	81349	TRANSISTOR	EA	4
12	10	PADZZ	5961-761-4504	2N4949	81349	TRANSISTOR	EA	1
12	11	PADZZ	5905-988-2309	RN60D100CF	81349	RESISTOR, FIXED, FILM	EA	2
12	12	PADZZ	5905-983-6914	RN60D1002F	81349	RESISTOR, FIXED, FILM	EA	2
12	13	PADZZ	5905-758-3446	RN60D68R1F	81349	RESISTOR, FIXED, FILM	EA	1
12	14	PADZZ	5905-194-1695	RN60D4751F	81349	RESISTOR, FIXED, FILM	EA	1
12	15	PADZZ	5905-189-2467	RN60D3011F	81349	RESISTOR, FIXED, FILM	EA	1
12	16	PADZZ	5905-195-6404	RN60D3922F	81349	RESISTOR, FIXED, FILM	EA	1
12	17	PADZZ	5905-682-7773	RN60D4990F	81349	RESISTOR, FIXED, FILM	EA	7
12	18	PADZZ	5905-138-1285	RN60D2001F	81349	RESISTOR, FIXED, FILM	EA	1
12	19	PADZZ	5905-988-2310	RN60D1000F	81349	RESISTOR, FIXED, FILM	EA	1
12	20	PADZZ	5905-721-2385	RN60D3322F	81349	RESISTOR, FIXED, FILM	EA	1
12	21	PADZZ	5905-432-6410	RN60D1001F	81349	RESISTOR, FIXED, FILM	EA	2
12	22	PADZZ	5905-452-0768	RN60D6191F	81349	RESISTOR, FIXED, FILM	EA	1
12	23	PADZZ	5905-137-0804	RN60D1003F	81349	RESISTOR, FIXED, FILM	EA	1
12	24	PADZZ	5962-247-3392	SN5440J	01295	INTEGRATED CIRCUIT, INPUT BUFFER	EA	1
GROUP 1A1A11 LOADS BOARD NO 1								
13	1	PADZZ	5910-456-0812	CM06FD511J03	81349	CAPACITOR, FIXED, MICAELECTRIC	EA	1
13	2	PADZZ	5935-236-7836	UPCCSGM23AAEF	97954	CONNECTOR, RECEPTACLE, ELECTRICAL	EA	1
13	3	PADZZ	5905-984-7681	RN60D2002F	81349	RESISTOR, FIXED, FILM	EA	1
13	4	PADZZ	5905-983-6914	RN60D1002F	81349	RESISTOR, FIXED, FILM	EA	7
13	5	PADZZ	5905-142-0931	RN60D5111F	81349	RESISTOR, FIXED, FILM	EA	2
13	6	PADZZ	5905-233-7141	RN60D2741F	81349	RESISTOR, FIXED, FILM	EA	1
GROUP 1A1A12 LOADS BOARD NO 2								
14	1	PADZZ		UPCCSGM23AAEH	97954	CONNECTOR, RECEPTACLE, ELECTRICAL	EA	1
14	2	PADZZ	5905-983-6914	RN60D1002F	81349	RESISTOR, FIXED, FILM	EA	6
GROUP 1A1A13 ASSEMBLY, HEATSINK								
15	1	PAHZZ	5910-957-0676	CL65BF150MP3	81349	CAPACITOR, FIXED, ELECTROLYTIC	EA	1
15	2	PAHZZ	5935-489-9999	M24308-4-3	81349	CONNECTOR, PLUG, ELECTRICAL	EA	1
15	3	XBHZZ		SK416-4	24434	INSULATOR, DISK	EA	2
15	4	PAHZZ	5940-905-4576	SE209D01	81349	TERMINAL, STUD	EA	7
15	5	PAHZZ	5961-069-2469	2N1724	81349	TRANSISTOR	EA	2
15	6	PAHZZ	5961-923-3951	2N2151	81349	TRANSISTOR	EA	1
15	7	PADZZ	5905-983-6914	RN60D1002F	81349	RESISTOR, FIXED, FILM	EA	2
GROUP 1A1A14 ASSEMBLY, HEATSINK								
16	1	XBHFF	5961-767-1522	BBT0-3-62	05451	INSULATOR, PLATE	EA	4
16	2	PAHZZ	5935-490-3743	M24308-4-2	81349	CONNECTOR, PLUG, ELECTRICAL	EA	1
16	3	PAHZZ	5961-085-0468	2N3902	81349	TRANSISTOR	EA	4

SEE NOTE 3

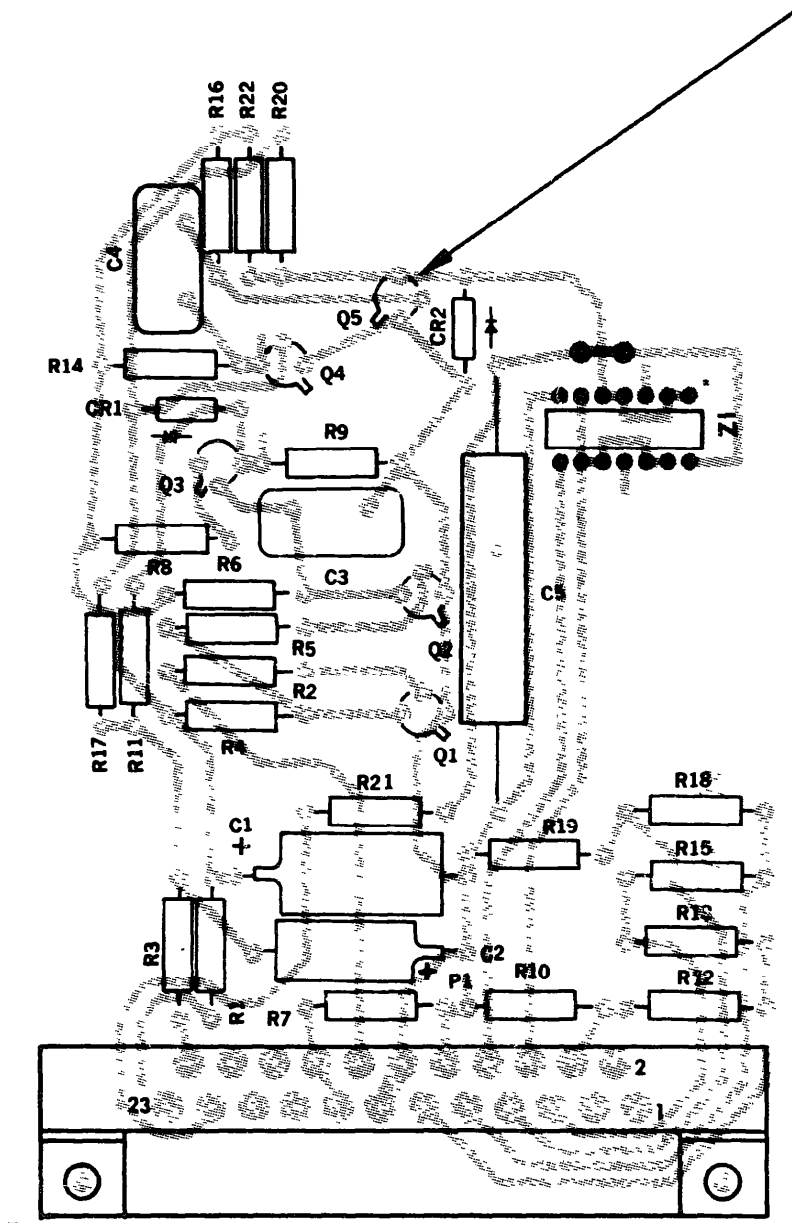

REF DES	ITEM NO	REF DES	ITEM NO
C1	1	R4	14
C2	2	R5	15
C3	3	R6	16
C4	4	R7	17
C5	5	R8	18
CR1	6	R9	19
CR2	6	R10	17
E1	7	R11	20
E2	7	R12	17
E3	7	R13	17
E4	7	R14	21
E5	7	R15	17
P1	8	R16	22
Q1	9	R17	23
Q2	9	R18	17
Q3	10	R19	17
Q4	9	R20	12
Q5	9	R21	11
R1	11	R22	21
R2	12	Z1	24
R3	13		

LEGEND

BASING DIAGRAMS ARE SHOWN FROM THE TOP AS ON THE PART LOCATION DIAGRAM.

TRANSISTOR (Q)

INTEGRATED CIRCUIT
14-PIN DUAL-INLINE (Z)

UNIUNCTION TRANSISTOR (Q)

NOTE:

1. LIGHT SHADING INDICATES ETCHED SIDE CIRCUIT PATTERN-DARK SHADING INDICATES COMPONENT SIDE PATTERN.
2. FOR COMPLETE REFERENCE DESIGNATION PREFIX WITH 1A1A10
3. EACH TRANSISTOR (Q1 THROUGH Q5) IS MOUNTED ON AN INSULATOR DISK (E1 THROUGH E5).

EL6625-1824-40P-TM-12

Figure 12. Generator, hot spot

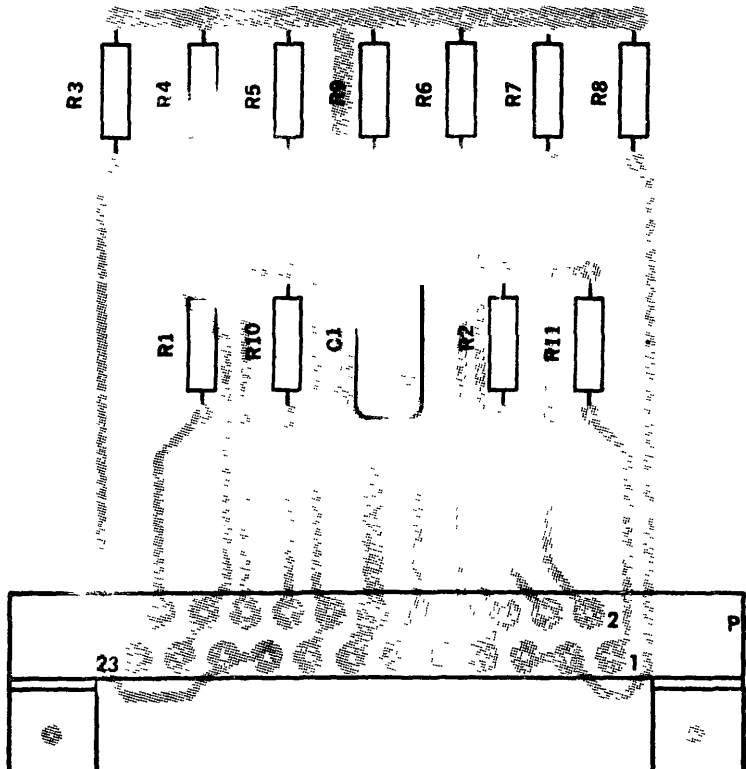

REF DES	ITEM NO	REF DES	ITEM NO	REF DES	ITEM NO	REF DES	ITEM NO
C1	1	R3	5	R7	4	R11	4
PI	2	R4	5	R8	4		
R1	3	R5	4	R9	6		
R2	4	R6	4	R10	4		

NOTE :

1. LIGHT SHADING INDICATES ETCHED SIDE
CIRCUIT PATTERN-DARK SHADING INDICATES
COMPONENT SIDE PATTERN.
2. FOR COMPLETE REFERENCE DESIGNATION
PREFIX WITH 1A1A11

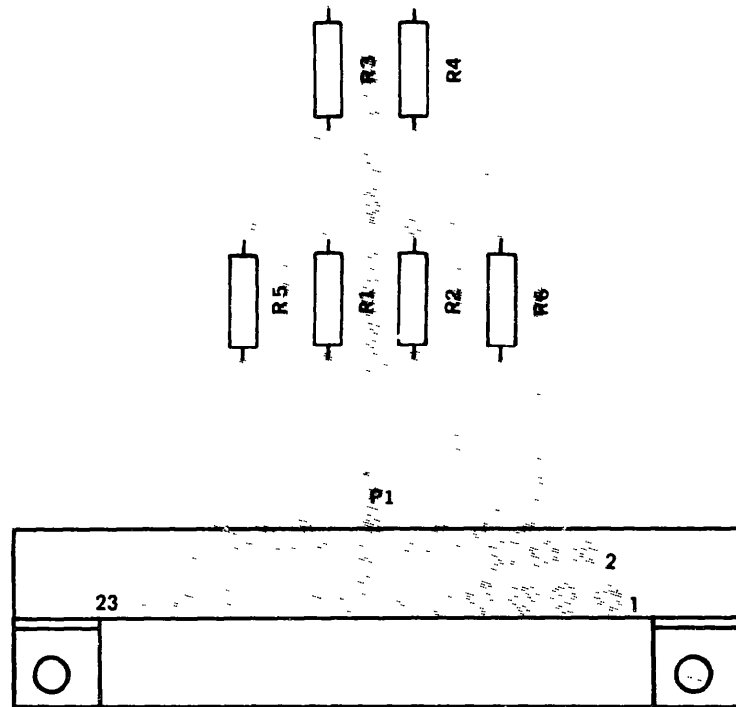

REF DES	ITEM NO	REF DES	ITEM NO	REF DES	ITEM NO
P1	1	R3	2	R6	2
R1	2	R4	2		
R2	2	R5	2		

NOTE :

1. LIGHT SHADING INDICATES ETCHED SIDE
CIRCUIT PATTERN-DARK SHADING INDICATES
COMPONENT SIDE PATTERN.
2. FOR COMPLETE REFERENCE DESIGNATION
PREFIX WITH 1A1A12

Figure 14. Loads board No. 2

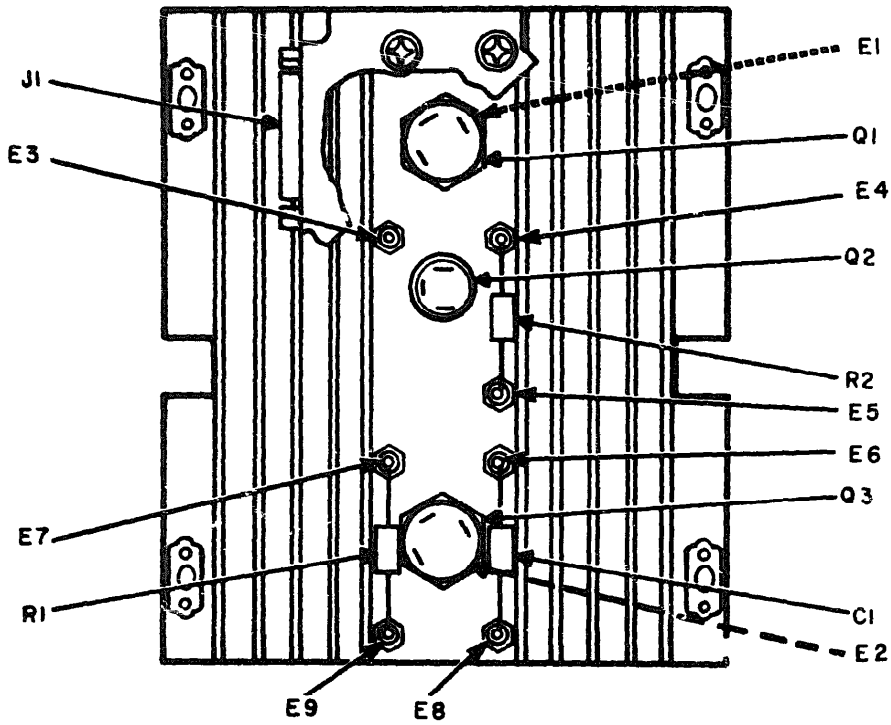

REF DES	ITEM NO	REF DES	ITEM NO
C1	1	E7	4
J1	2	E8	4
E1	3	E9	4
E2	3	Q1	5
E3	4	Q2	6
E4	4	Q3	5
E5	4	R1	7
E6	4	R2	7

NOTE :

1. FOR COMPLETE PREFIX REFERENCE DESIGNATOR PREFIX WITH IA1A13.

EL6625-1824-40P-TM-15

Figure 15. Assembly, heatsink IA1A13

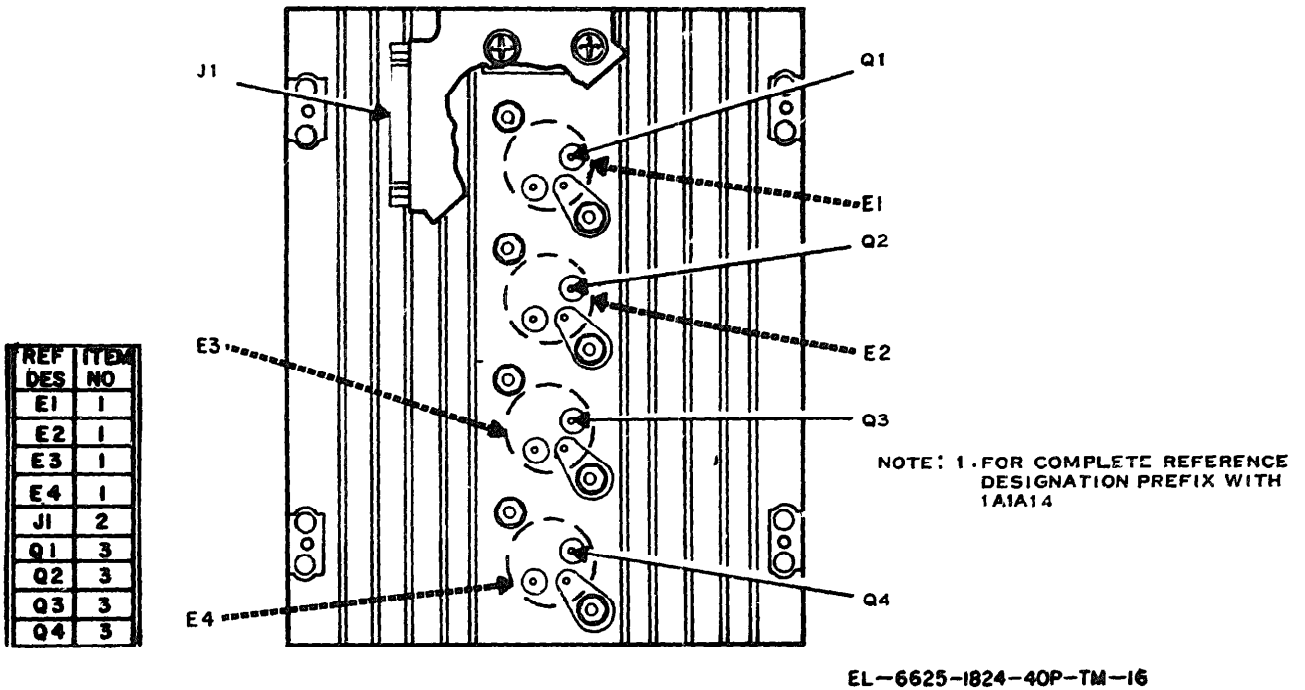

Figure 16. Assembly, heatsink 1A1A14

SECTION II REPAIR PARTS LIST (CONTINUED)

(1) ILLUSTRATION		(2) SMR CODE	(3) FEDERAL STOCK NUMBER	(4) PART NUMBER	(5) FSCM	(6) DESCRIPTION	(7) UNIT OF MEAS	(8) QTY INC IN UNIT
(A) FIG NO.	(B) ITEM NO.							
GROUP 1A1A15 ASSEMBLY, FILTER								
17	1	PAHZZ	5905-410-7428	RM6901004F	81349	RESISTOR, FIXED, FILM	EA	1
17	2	PAHZZ	5950-433-2451	712384-1	96214	INDUCTOR, POWER	EA	1
17	3	PAHZZ	5935-838-3695	MS3124E12-3P	96906	CONNECTOR, RECEPTACLE, ELECTRICAL	EA	1
17	4	PAHZZ	5935-880-8896	MS3124E11-5P	96906	CONNECTOR, RECEPTACLE, ELECTRICAL	EA	1
17	5	PAHZZ	5915-127-4305	963-000-1002	72982	FILTER, ELECTROMAGNETIC	EA	2
17	6	PAHZZ	5942-822-4549	71279	71279	TERMINAL, STUD	EA	1
17	7	PAHZZ	5915-996-1409	71279	56289	FILTER, ELECTROMAGNETIC	EA	1
17	8	PAHZZ	5940-905-4576	SEL49001	81349	TERMINAL, STUD	EA	2
17	9	PAHZZ	5910-353-0552	MS312-02-0441	81349	CAPACITOR, FIXED, PAPER DIELECTRIC	EA	1
17	10	PAHZZ	5910-949-4225	71279	56289	CAPACITOR, FIXED, METALIZED	EA	1
17	11	PAHZZ	5950-433-4451	712384-1	96214	INDUCTOR, POWER	EA	1
17	12	PAHZZ	5950-433-2451	712384-1	96214	INDUCTOR, POWER	EA	1
GROUP 1W CABLE ASSEMBLIES								
18	1	PAHZZ	5935-585-5233	33-106	72653	PROBE, TEST	EA	1
18	2	PAHZZ	6625-459-3401	33-108	72653	PROBE, TEST	EA	1
18	3	PACDD	6625-196-2844	CA12408/U	30058	CABLE ASSEMBLY, POWER ELECTRICAL	EA	1
18	4	PAHZZ	5935-765-5991	MS3126F12-3S	96906	CONNECTOR, PLUG, ELECTRICAL	EA	1
18	5	PAHZZ	5935-843-7133	UP106M	30058	CONNECTOR, PLUG, ELECTRICAL	EA	1
18	6	PACDD	6625-470-4315	CA12409/U	30058	CABLE ASSEMBLY, POWER ELECTRICAL	EA	1
18	7	PAHZZ	5935-761-3885	MS3126F14-5S	96906	CONNECTOR, PLUG, ELECTRICAL	EA	1
18	8	PAHZZ	5935-724-7584	MS3126F22-55SE	96906	CONNECTOR, PLUG, ELECTRICAL	EA	1
18	9	PACDD	6625-439-2669	CA12432/AAM-35	30058	CABLE ASSEMBLY, SPECIAL PURPOSE ELECTRICAL	EA	1
18	10	PAHZZ	5935-724-7579	MS3126F12-2-55PW	96906	CONNECTOR, PLUG, ELECTRICAL	EA	1
18	11	PAHZZ	5935-724-7577	MS3126F14-12C	96906	CONNECTOR, PLUG, ELECTRICAL	EA	1
18	12	PACDD	6625-439-2669	CA12433/AAM-35	30058	CABLE ASSEMBLY, SPECIAL PURPOSE, ELECTRICAL	EA	1
18	13	PAHZZ	5935-724-7567	MS3126F14-12P	96906	CONNECTOR, PLUG, ELECTRICAL	EA	1
18	14	PAHZZ	5935-724-7580	MS3126F22-55S	96906	CONNECTOR, PLUG, ELECTRICAL	EA	1
18	15	PACDD	6625-489-2670	CA12434/AAM-35	30058	CABLE ASSEMBLY, SPECIAL PURPOSE, ELECTRICAL	EA	1
18	16	PAHZZ	5935-724-7578	MS3126F22-55P	96906	CONNECTOR, PLUG, ELECTRICAL	EA	1
18	17	PAHZZ	5935-198-3903	L22TF95F6V1	39922	CONNECTOR, PLUG, ELECTRICAL	EA	1
18	18	PACDD	6625-489-0462	CA12435/AAM-35	30058	CABLE ASSEMBLY, SPECIAL PURPOSE, ELECTRICAL	EA	1
18	19	PAHZZ	5935-402-6933	L22TF95S6N1	39922	CONNECTOR, PLUG, ELECTRICAL	EA	1
18	20	PAHZZ	5935-497-0928	L22TF9536Y1	39922	CONNECTOR, PLUG, ELECTRICAL	EA	1
18	21	PACDD	6625-242-5796	CA12436/AAM-35	30058	CABLE ASSEMBLY, SPECIAL PURPOSE, ELECTRICAL	EA	1
18	22	PAHZZ	5935-238-0610	L22TF95F6W1	39922	CONNECTOR, PLUG, ELECTRICAL	EA	1
GROUP 2 TEST SET, CONVERTER								
SUBASSEMBLY UNIT 2								
19	1	PACDD	6625-489-0435	CA1109/AAM-35	30058	CONVERTER, TEST SET SUBASSEMBLY	EA	1
19	2	PACDD	6625-409-8158	MX8749/AAM-35	30058	TEST SET SUBASSEMBLY	EA	1
19	3	XAHDD		694614-1	96214	ELECTRONIC CONTROL UNIT, MOTOR	EA	1

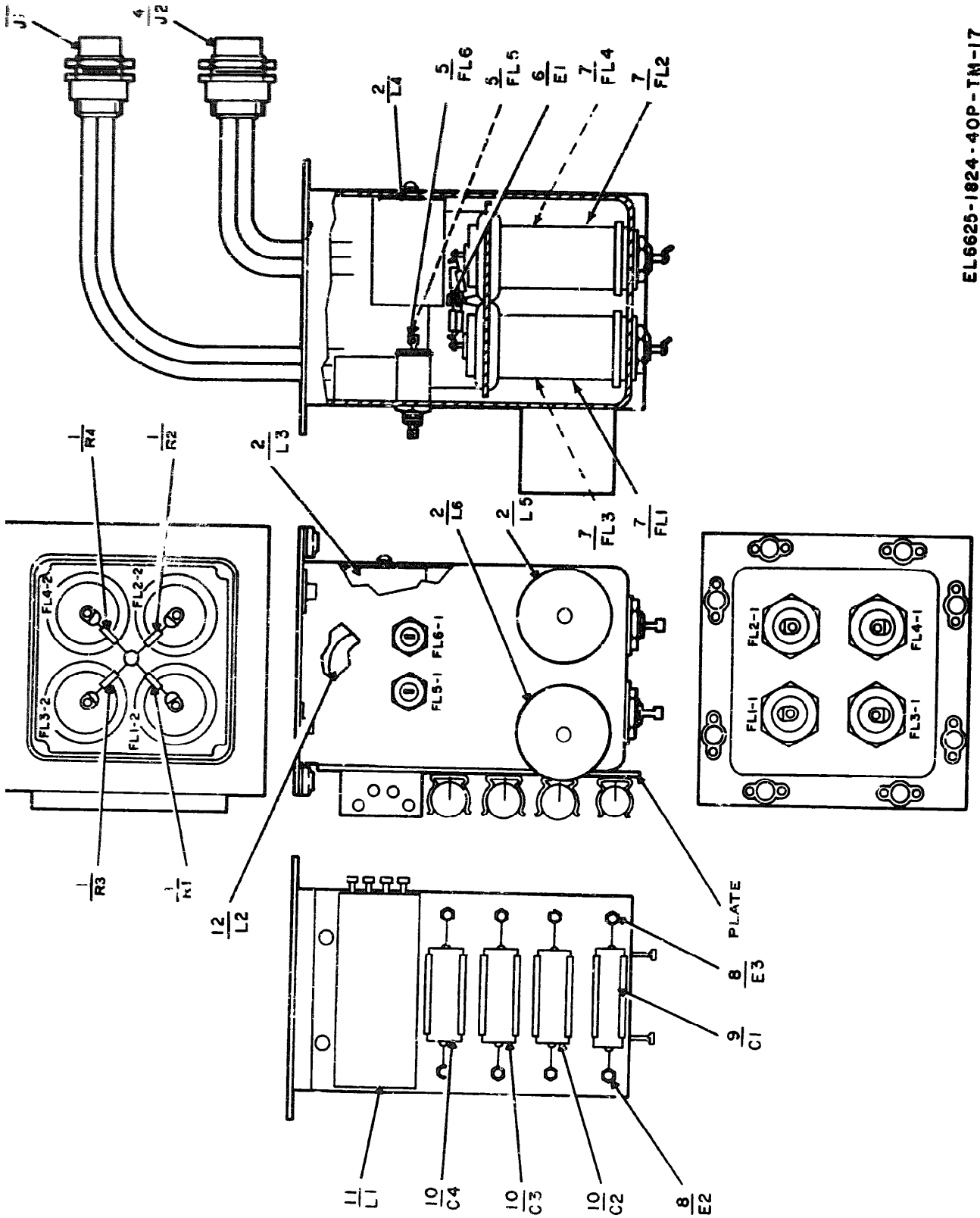
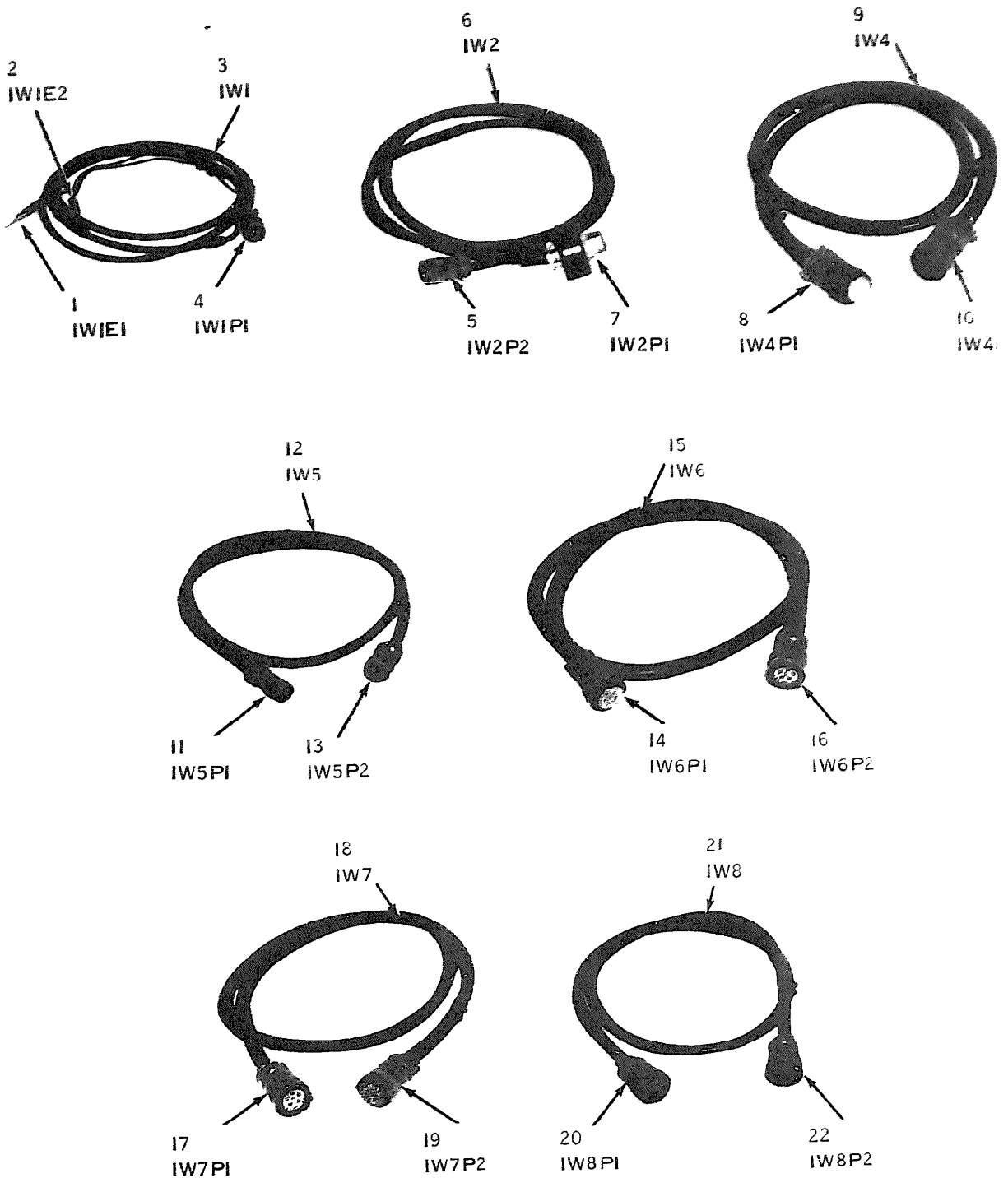
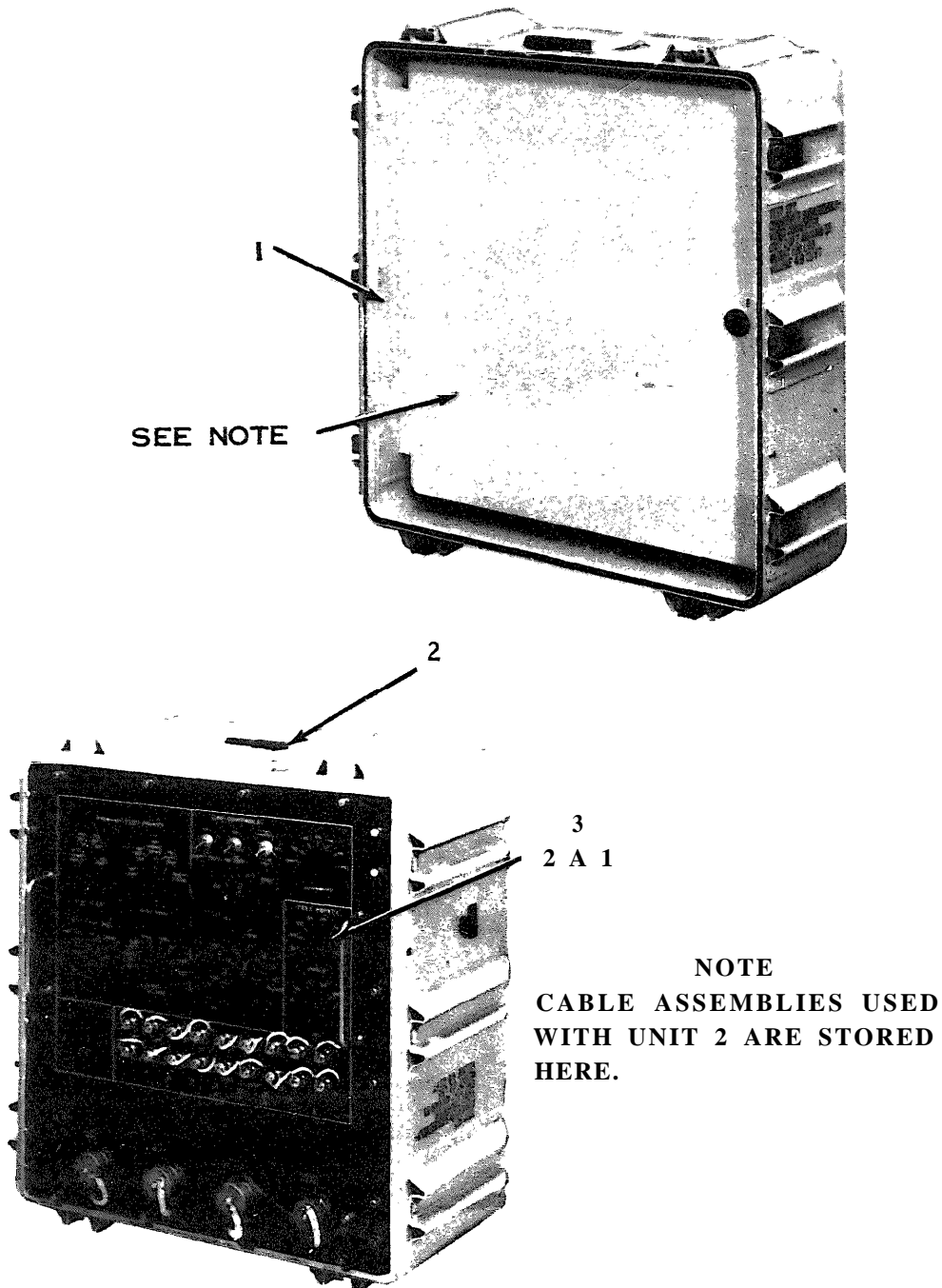

Figure 17. Assembly filter



EL 6625 - 1824 - 40P - TM -

Figure 18. Cable assembly IW



EL 6625-1824-40P-TM-19

Figure 19 Test set converter subassembly unit 2

SECTION II REPAIR PARTS LIST (CONTINUED)

(1) ILLUSTRATION		(2) SMR CODE	(3) FEDERAL STOCK NUMBER	(4) PART NUMBER	(5) FSCM	(6) DESCRIPTION	(7) UNIT OF MEAS	(8) QTY INC IN UNIT
(A) FIG NO.	(B) ITEM NO.							
GROUP 2A1 CONTROL UNIT 2								
20	1	PAHZZ	5935-260-2686	KC79-43	91836	CONNECTOR, RECEPTACLE, ELECTRICAL	EA	12
20	2	PAH77	5935-702-4199	M39024-10-02	81349	JACK, TIP	EA	7
20	3	PAH27	5935-762-0312	M39024-10-03	81349	JACK, TIP	EA	1
20	4	PAHZZ	5905-233-6848	RE77G6R81	81349	RESISTOR, FIXED, WIREWOUND	EA	1
20	5	PAHZZ	5905-405-1171	RE77G2001	81349	RESISTOR, FIXED, WIREWOUND	EA	1
20	6	PAHZZ	5905-243-8473	RE77G4R64	81349	RESISTOR, FIXED, WIREWOUND	EA	1
20	7	PAHHD	6110-489-0041	692235-1	96214	ASSEMBLY, HEATSINK	EA	1
20	8	PAHHD	6625-409-9068	692463-1	96214	OSCILLATOR, 100KHZ	EA	1
20	9	PAHDD	6625-463-3983	725096-1	96214	GENERATOR, SYNCHRONOUS	EA	1
20	10	PAHDD	6625-463-3986	725099-1	96214	GENERATOR, READ VERTICAL SWEEP	EA	1
20	11	PAHDD	6625-463-3982	725102-1	96214	GENERATOR, WRITE HORIZONTAL SWEEP	EA	1
20	12	PAHDE	6625-463-3989	725105-1	96214	SLFW, WRITE HORIZONTAL AND FIELD-OF-VIEW ADJER	EA	1
20	13	PAHED	6625-463-3972	725108-1	96214	AMPLIFIER, WRITE VIDEO	EA	1
20	14	PAHDD	6625-463-3973	725111-1	96214	GENERATOR, VELOCITY/HEIGHT CLOCK PULSE	EA	1
20	15	PAHDD	6625-463-3986	725114-1	96214	GENERATOR, WRITE VERTICAL SWEEP	EA	1
20	16	PAHDD	6625-463-3993	725117-1	96214	GENERATOR, ERASE VERTICAL SWEEP	EA	1
20	17	PAHDD	6625-463-3968	725120-1	96214	LOGIC, AUXILIARY DEFLECTION	EA	1
20	18	PAHDD	6625-463-3991	725123-1	96214	GENERATOR, DITHEP	EA	1
20	19	PAHDE	6625-409-0930	692472-1	96214	SWEEP AND BLANKING, GENERATOR CS-JC	EA	1
20	20	PAHDE	6625-186-2854	692475-1	96214	STORAGE TUBE PROTECT, LOADS AND VIDEO AMPLIFIER	EA	1
20	21	PAHDE	6625-463-3976	725126-1	96214	POWER SUPPLY, +15VD	EA	1
20	22	PAH77	5935-243-8497	RE77G6R81	81349	RESISTOR, FIXED, WIREWOUND	EA	1
20	23	PAH77	5935-243-8498	RE77G6R81	81349	RESISTOR, FIXED, WIREWOUND	EA	1
20	24	PAH77	5935-243-8499	RE77G6R81	81349	RESISTOR, FIXED, WIREWOUND	EA	1
20	25	PAH77	5935-243-8500	RE77G6R81	81349	RESISTOR, FIXED, WIREWOUND	EA	1
20	26	PAH77	5935-243-8501	RE77G6R81	81349	RESISTOR, FIXED, WIREWOUND	EA	1
20	27	PAHZZ	5930-09-7796	418633-71	96214	SWITCH, ROTARY	EA	1
20	28	PAHZZ	5930-685-9559	MS35059-19	96906	SWITCH, TOGGLE	EA	1
20	29	PAHZZ	5935-404-8715	418633-72	96214	SWITCH, ROTARY	EA	1
20	30	PAHZZ	5930-615-9376	MS35059-21	96906	SWITCH, TOGGLE	EA	1
20	31	PAHZZ	5930-167-7749	418633-75	96214	SWITCH, ROTARY	EA	1
20	32	PAHZZ	5930-350-1770	418633-73	96214	SWITCH, ROTARY	EA	1
20	33	PAH77	5935-243-8475	RE77G6R81	81349	RESISTOR, FIXED, WIREWOUND	EA	1
20	34	PAH77	5935-243-8498	RE77G6R81	81349	RESISTOR, FIXED, WIREWOUND	EA	1
20	35	PAH77	5935-243-8597	RE77G6R81	81349	RESISTOR, FIXED, WIREWOUND	EA	1
20	36	PAH77	5935-243-8575	RE77G6R81	81349	RESISTOR, FIXED, WIREWOUND	EA	1
20	37	PAH77	5935-243-8575	RE77G6R81	81349	RESISTOR, FIXED, WIREWOUND	EA	1
20	38	PAH77	5935-243-8497	RE77G6R81	81349	RESISTOR, FIXED, WIREWOUND	EA	1
20	39	PAH77	5935-243-8498	RE77G6R81	81349	RESISTOR, FIXED, WIREWOUND	EA	1
20	40	PAH77	5935-243-8489	RE77G6R81	81349	RESISTOR, FIXED, WIREWOUND	EA	1
20	41	PAH77	5935-243-8486	RE77G6R81	81349	RESISTOR, FIXED, WIREWOUND	EA	1
20	42	PAH77	5935-405-7596	RE77G6R81	81349	RESISTOR, FIXED, WIREWOUND	EA	1

SECTION II REPAIR PARTS LIST (CONTINUED)

(1) ILLUSTRATION		(2) SMR CODE	(3) FEDERAL STOCK NUMBER	(4) PART NUMBER	(5) FSCM	(6) DESCRIPTION	(7) UNIT OF MEAS	(8) QTY INC IN UNIT
(A) FIG NO.	(B) ITEM NO.							
20	43	PAHZZ	5835-243-8493	REPCSGF23ADJ	97954	CONNECTOR, PLUG, ELECTRICAL	EA	1
20	44	PAHZZ	5940-419-9722	692287-2	96214	TERMINAL STRIP	EA	1
20	45	PAHZZ	5935-243-8492	REPCSGF23ADH	97954	CONNECTOR, PLUG, ELECTRICAL	EA	1
20	46	PAHZZ	5935-243-8501	REPCSGF23ADR	97954	CONNECTOR, PLUG, ELECTRICAL	EA	1
20	47	PAHZZ	5935-405-1172	REPCSGF23AEK	97954	CONNECTOR, PLUG, ELECTRICAL	EA	1
20	48	PAHZZ	5935-497-0932	REPCSGF23ACL	97954	CONNECTOR, PLUG, ELECTRICAL	EA	1
20	49	PAHZZ	5940-905-4576	SE209D01	81349	TERMINAL, STUD	EA	16
20	50	PADZZ	5905-682-7773	RN60D4990F	81349	RESISTOR, FIXED, FILM	EA	7
20	51	PADZZ	5905-983-6914	RN60D10027	81349	RESISTOR, FIXED, FILM	EA	2
20	52	PAHZZ	5905-764-2615	RN60F5181F	81349	RESISTOR, FIXED, FILM	EA	1
20	53	PAHZZ	5935-350-1771	418633-67	96214	SWITCH, ROTARY	EA	2
20	54	PAHZZ	5930-167-7749	418633-72	96214	SWITCH, ROTARY	EA	1
20	55	PAHZZ	5930-113-7582	418633-74	96214	SWITCH, ROTARY	EA	1
20	56	PAHZZ	5905-552-2588	RA20SAYSD503A	81349	RESISTOR, VARIABLE, COMPOSITION	EA	1
20	57	PAHZZ	5905-811-4372	RA20SACK103A	81349	RESISTOR, VARIABLE, WIREWOUND	EA	3
20	58	PAHZZ	5905-851-9540	RA20SASK502A	81349	RESISTOR, VARIABLE, WIREWOUND	EA	1
20	59	PAHZZ	5930-655-1582	MS35059-23	96906	SWITCH, TOGGLE	EA	1
20	60	PAHZZ	5930-184-7763	418633-70	96214	SWITCH, ROTARY	EA	1
20	61	PADZZ	5355-985-5888	MS91528-2M2B	96906	KNOB, CONTROL	EA	9
20	62	PADZZ	5355-567-8589	MS91528-2D2B	96906	KNOB, CONTROL	EA	5
20	63	Y84FF		692613-1	96214	PLATE, IDENTIFICATION	EA	2
GROUP 2A1A1 OSCILLATOR, 100KHZ								
21	1	PADZZ	5910-051-2232	L79ALAZ24J	01884	CAPACITOR, FIXED, PLASTIC DIELECTRIC	EA	1
21	2	PADZZ	5910-984-7588	CM05FD101J73	81349	CAPACITOR, FIXED, MICA DIELECTRIC	EA	1
21	3	PADZZ	5910-822-5688	CR63AW103M	81349	CAPACITOR, FIXED, CERAMIC DIELECTRIC	EA	1
21	4	PADZZ	5961-846-9157	1N759A	81349	SEMICONDUCTOR DEVICE, DIODE	EA	1
21	5	PADZZ	5961-752-6121	1N753A	81349	SEMICONDUCTOR DEVICE, DIODE	EA	1
21	6	PADZZ	5999-484-5513	7717-18N	13103	INSULATOR, DISK	EA	1
21	7	PADZZ	5935-959-4929	8000AG9	91506	SOCKET, CRYSTAL	EA	1
21	8	PADZZ	5961-054-0339	7717-19DAP	13103	INSULATOR, DISK	EA	1
21	9	PADZZ	5935-260-3644	REPCSGF23AAE7	97954	CONNECTOR, RECEPTACLE, ELECTRICAL	EA	1
21	10	PADZZ	5961-951-8757	2N2272A	81349	TRANSISTOR	EA	1
21	11	PADZZ	5905-432-6411	RN60D33.0F	81349	RESISTOR, FIXED, FILM	EA	1
21	12	PADZZ	5905-137-0806	RN60D9090F	81349	RESISTOR, FIXED, FILM	EA	1
21	13	PADZZ	5905-452-0769	RN60D6700F	81349	RESISTOR, FIXED, FILM	EA	1
21	14	PADZZ	5905-985-6914	RN60D1002F	81349	RESISTOR, FIXED, FILM	EA	2
21	15	PADZZ	5905-069-3917	RN60D8241F	81349	RESISTOR, FIXED, FILM	EA	1
21	16	PADZZ	5905-208-3800	RN60D4752F	81349	RESISTOR, FIXED, FILM	EA	1
21	17	PADZZ	5905-892-6578	RN60D1712F	81349	RESISTOR, FIXED, FILM	EA	1
21	18	PADZZ	5905-432-6410	RN60D1001F	81349	RESISTOR, FIXED, FILM	EA	1
21	19	PADZZ	5955-882-8346	CR37AN100KH7	81349	CRYSTAL UNIT, QUARTZ	EA	1
21	20	PADZZ	5962-248-3336	SN52710L	01295	INTEGRATED CIRCUIT, DIFFERENTIATING COMPARTOR	EA	1

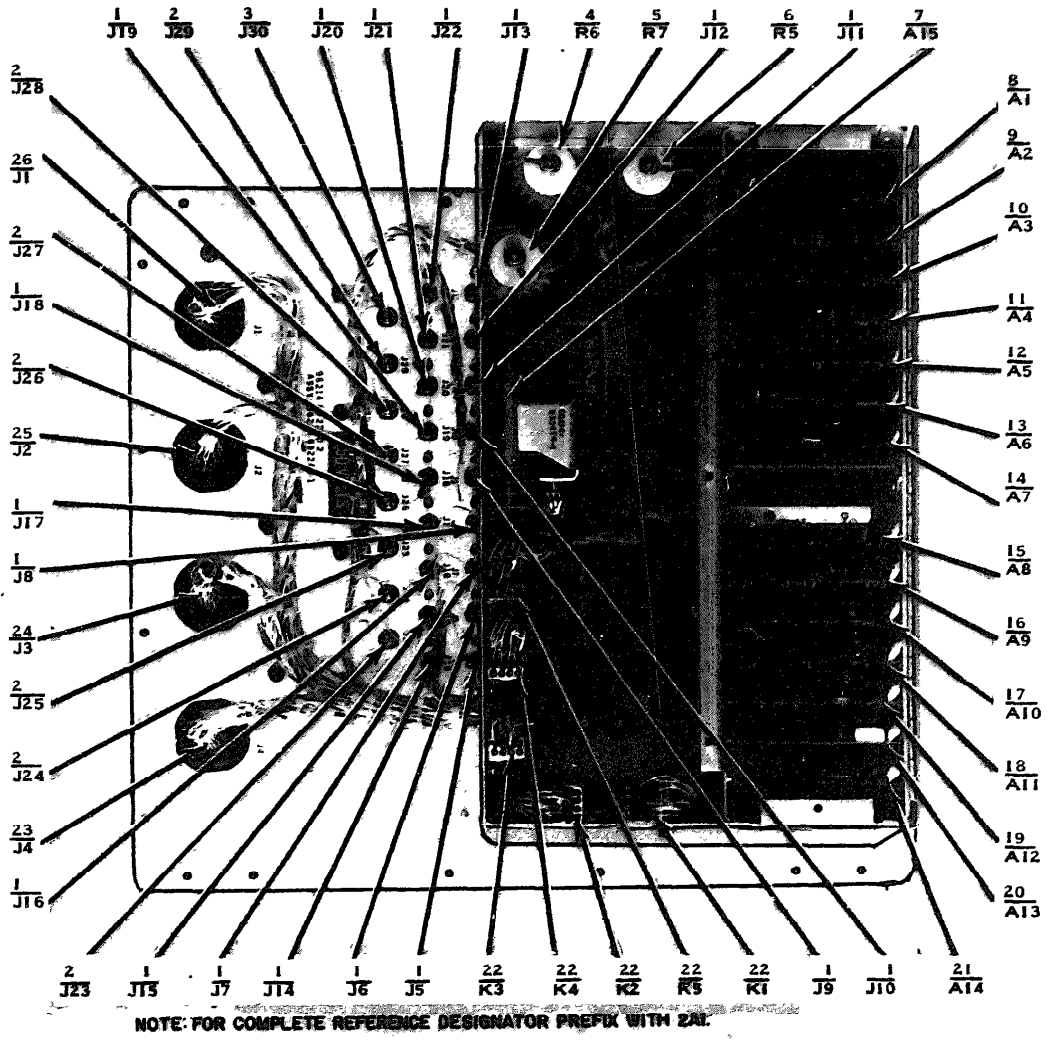

EL 6625 - 1824 - 40P - TM - 20 (1)

Figure 20-1. Control unit 2 (sheet 1 of 3)

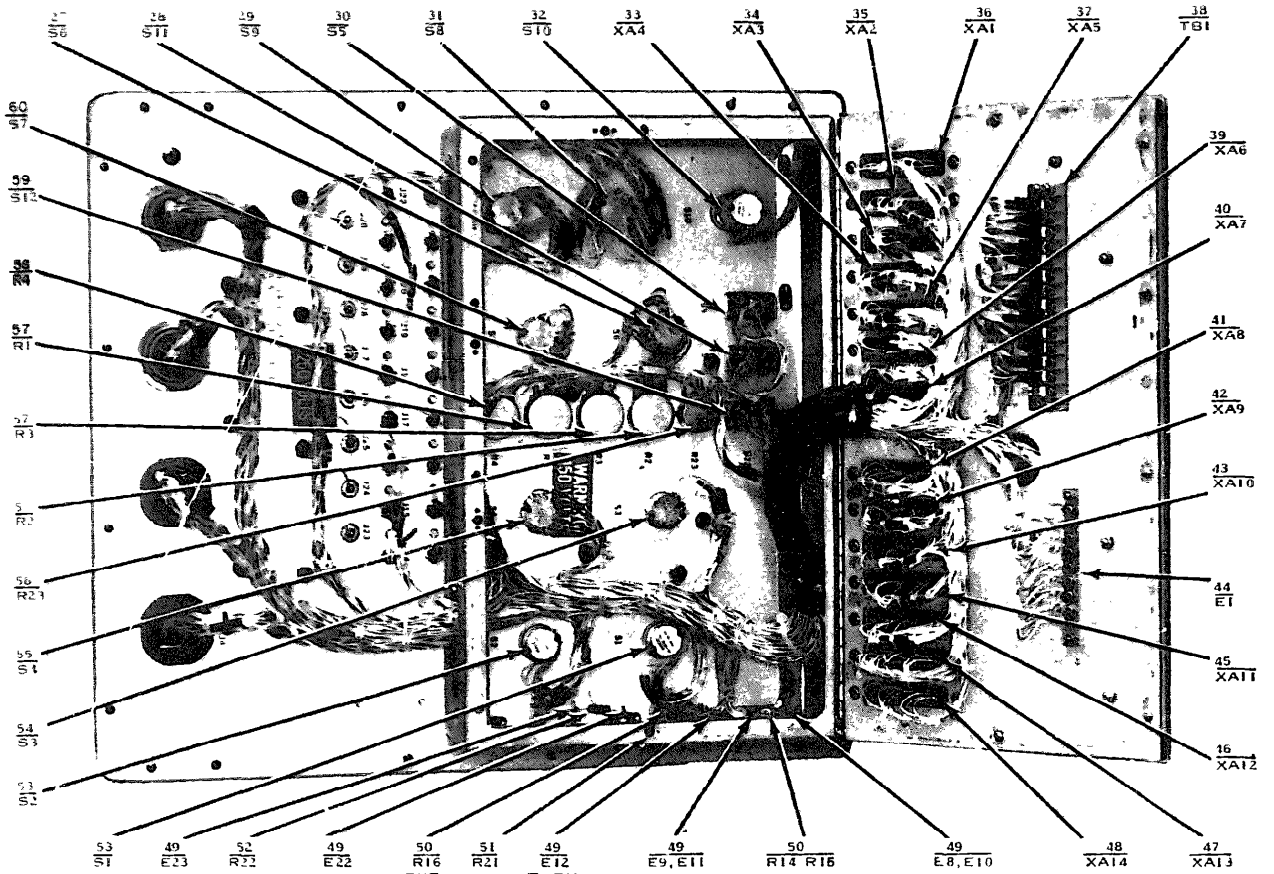

NOTE FOR COMPLETE REFERENCE DESIGNATOR PREFIX WITH 2A1

EL 66-5 1824-40P-TM 23 (2)

Figure 20-2 Control unit 2 (sheet 2 or 3)

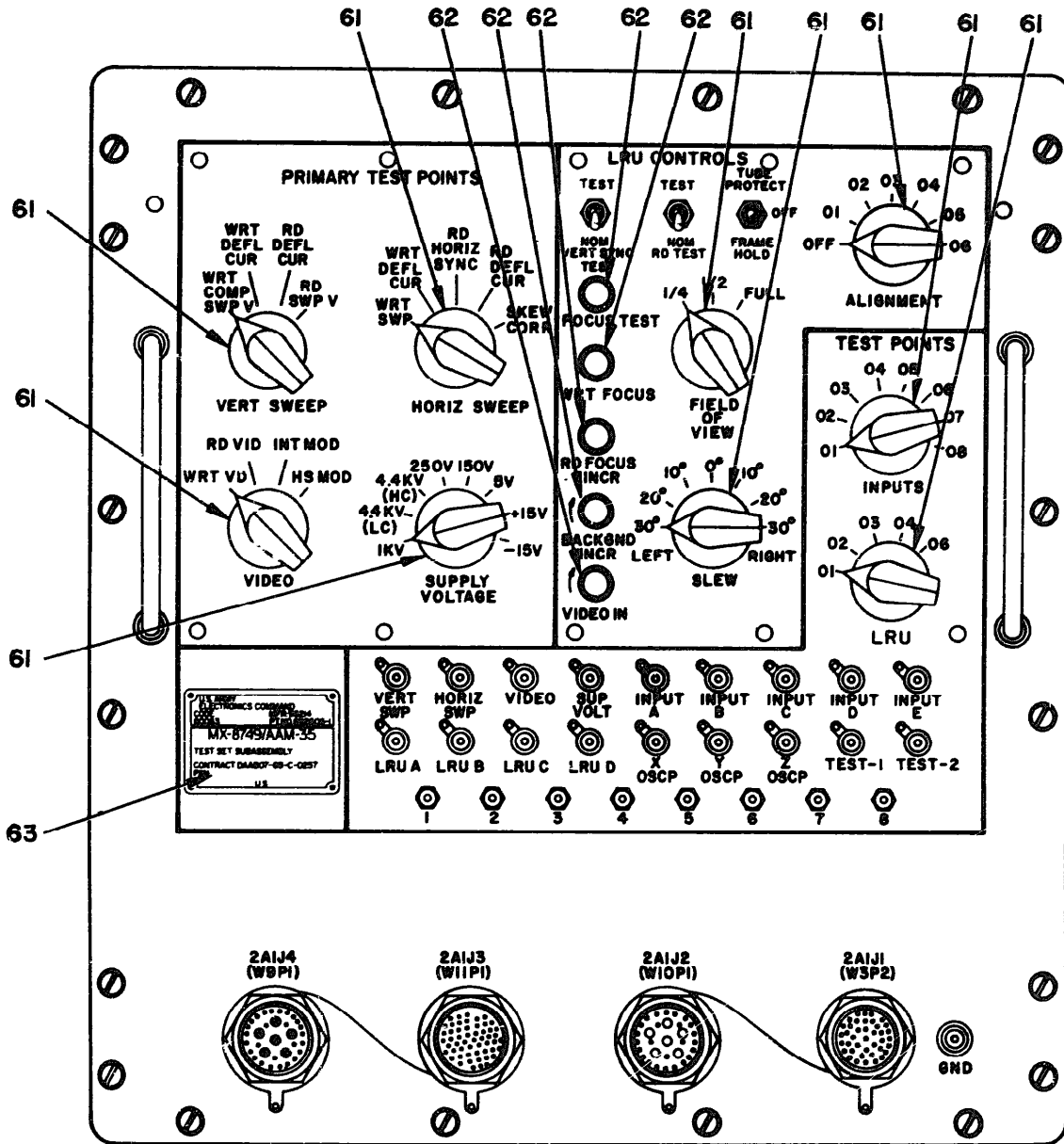

EL6625-1824-40P-TM-20 ⑤

Figure 20-3 Control unit 2 (sheet 3 of 3)

REF. DES.	ITEM NO.
C1	1
C2	2
C3	3
CR1	4
CR2	5
E1	6
E2	7
E3	8
P1	9
Q1	10
R1	11
R2	12
R3	13
R4	14
R5	15
R6	16
R7	17
R8	14
R9	14
R10	14
R11	18
Y1	19
Z1	20

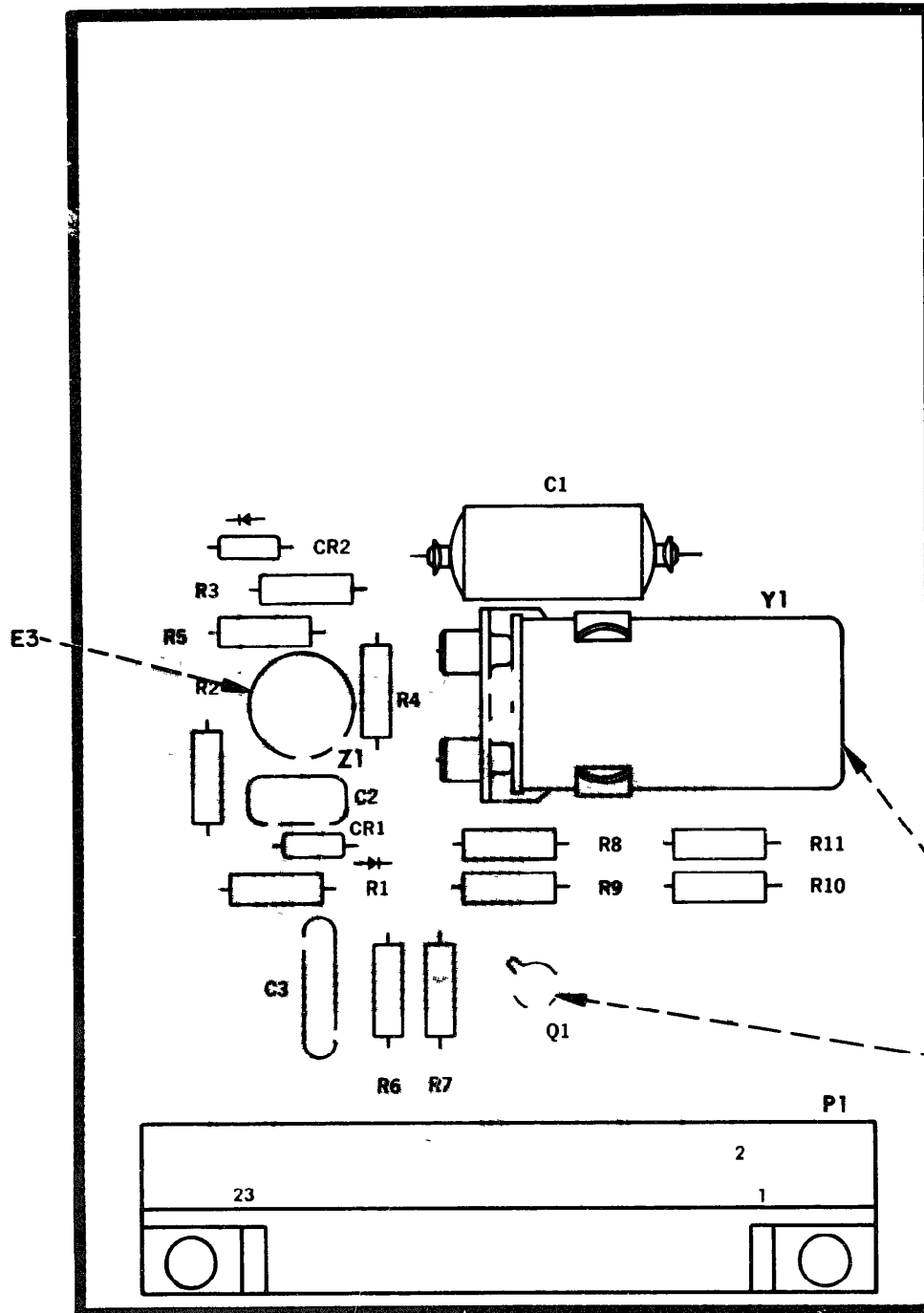
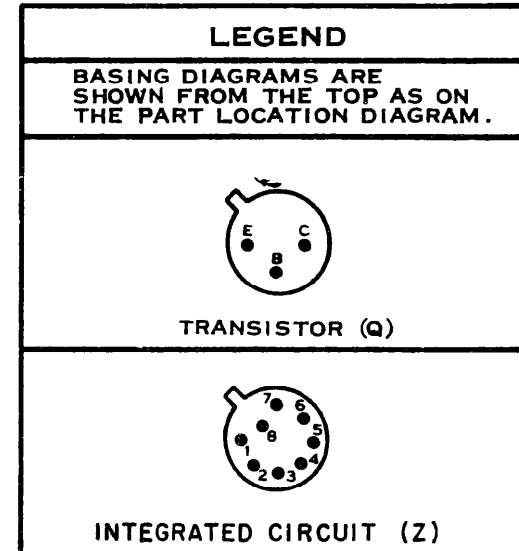

NOTE:

1. LIGHT SHADING INDICATES ETCHED SIDE CIRCUIT PATTERN-DARK SHADING INDICATES COMPONENT SIDE PATTERN.
2. FOR COMPLETE REFERENCE DESIGNATION PREFIX WITH 2 AIAI.
3. E1, E2, AND E3 ARE INSULATOR DISKS MOUNTED UNDER Q1, Y1, AND Z1.

EL 6625-1824-40P-TM-21

Figure 21 Oscillator, 100 kHz

SECTION II REPAIR PARTS LIST (CONTINUED)

(1) ILLUSTRATION		(2) SMR CODE	(3) FEDERAL STOCK NUMBER	(4) PART NUMBER	(5) FSCM	(6) DESCRIPTION	(7) UNIT OF MEAS
(A) FIG NO.	(B) ITEM NO.						
GROUP 2A1A2 GENERATOR, SYNCHRONOUS							
22	1	PADZZ	5910-154-0547	CSR13F476KL	81349	CAPACITOR, FIXED, ELECTROLYTIC	EA
22	2	PADZ7	5910-113-5689	CSR13E476KL	81349	CAPACITOR, FIXED, ELECTROLYTIC	EA
22	3	PADZZ	5910-762-7886	CM06FD431J03	81349	CAPACITOR, FIXED, MICA DIELECTRIC	EA
22	4	PADZZ	5910-781-1154	CM06FD152J03	81349	CAPACITOR, FIXED, MICA DIELECTRIC	EA
22	5	PADZZ	5910-176-7335	CM05FD121J03	81349	CAPACITOR, FIXED, MICA DIELECTRIC	EA
22	6	PADZZ	5910-761-7112	CSP13F565KL	81349	CAPACITOR, FIXED, ELECTROLYTIC	EA
22	7	PADZ2	5910-164-2031	CSR13B565AL	81349	CAPACITOR, FIXED, ELECTROLYTIC	EA
22	8	PADZZ	5910-163-2189	CSR13G1039E	81349	CAPACITOR, FIXED, ELECTROLYTIC	EA
22	9	PADZ7	5910-096-4644	CK06BX330A	81349	CAPACITOR, FIXED, CERAMIC DIELECTRIC	EA
22	10	PADZ2	5951-342-9864	1N914	81349	SEMICONDUCTOR DEVICE, DIODE	EA
22	11	PADZ7	5999-484-5513	7717-18N	13103	INSULATOR, DISK	EA
22	12	PADZ7	T, e, 1X96-t	M39024-11-01	81349	JACK, TIP	EA
22	13	PADZZ	5935-131-9681	M39024-11-02	81349	JACK, TIP	EA
22	14	PADZZ	5935-131-9726	M39024-11-06	81349	JACK, TIP	EA
22	15	PADZ7	5935-131-9696	M39024-11-04	81349	JACK, TIP	EA
22	16	PADZ2	5935-131-9697	M39024-11-05	81349	JACK, TIP	EA
22	17	PADZ2	5950-921-3420	MS90537-49	96906	COIL, RADIO FREQUENCY	EA
22	18	PADZZ		UPCCSQM23AADS	97954	CONNECTOR, RECEPTACLE, ELECTRICAL	EA
22	19	PADZ7	961-951-977	2N2222A	81349	TRANSISTOR	EA
22	20	PADZ7	5905-732-3859	RN60D150F	81349	RESISTOR, FIXED, FILM	EA
22	21	PADZZ	5905-988-2309	RN60D100F	81349	RESISTOR, FIXED, FILM	EA
22	22	PADZ2	5905-194-1695	RN60D4751F	81349	RESISTOR, FIXED, FILM	EA
22	23	PADZ7	5905-137-0804	RN60D1003F	81349	RESISTOR, FIXED, FILM	EA
22	24	PADZ7	5905-432-6410	RN60D1701F	81349	RESISTOR, FIXED, FILM	EA
22	25	PADZ2	5905-983-6914	RN60D1002F	81349	RESISTOR, FIXED, FILM	EA
22	26	PADZ7	5905-489-2151	RT24C2P103	81349	RESISTOR, VARIABLE, WIREWOUND	EA
22	27	PADZ7	5905-452-0773	RN60D1622F	81349	RESISTOR, FIXED, FILM	EA
22	28	PADZ7	5905-208-3800	RN60D4752F	81349	RESISTOR, FIXED, FILM	EA
22	29	PADZ7	5962-117-6075	SN5473-1	01295	INTEGRATED CIRCUIT, FLIP-FLOP	EA
22	30	PADZ7	5961-117-6092	SN5473-1	01295	INTEGRATED CIRCUIT, INPUT GATE	EA
GROUP 2A1A3 GENERATOR, READ VERTICAL SWEEP							
22	1	PADZ7	5910-419-9329	CM06FD102J03	81349	CAPACITOR, FIXED, MICA DIELECTRIC	EA
22	2	PADZ7	5910-144-4383	CSP13F226KL	81349	CAPACITOR, FIXED, ELECTROLYTIC	EA
22	3	PADZ7	5910-154-0547	CSR13F476KL	81349	CAPACITOR, FIXED, ELECTROLYTIC	EA
22	4	PADZ7	5910-762-7886	CM06FD431J03	81349	CAPACITOR, FIXED, MICA DIELECTRIC	EA
22	5	PADZ7	5910-176-7335	CM05FD121J03	81349	CAPACITOR, FIXED, MICA DIELECTRIC	EA
22	6	PADZ7	5910-761-7112	CSP13F565KL	81349	CAPACITOR, FIXED, ELECTROLYTIC	EA
22	7	PADZ7	5910-236-8740	CSR13C476KL	81349	CAPACITOR, FIXED, ELECTROLYTIC	EA
22	8	PADZ2	5910-481-1626	CM06FD472J03	81349	CAPACITOR, FIXED, MICA DIELECTRIC	EA
22	9	PADZZ	5910-019-8718	CK06BX103K	81349	CAPACITOR, FIXED, CERAMIC DIELECTRIC	EA
22	10	PADZ7	5910-460-0869	CM05FD221J03	81349	CAPACITOR, FIXED, MICA DIELECTRIC	EA
22	11	PADZ7	5910-036-1037	CSR13G105ML	81349	CAPACITOR, FIXED, ELECTROLYTIC	EA

SEE NOTE 3

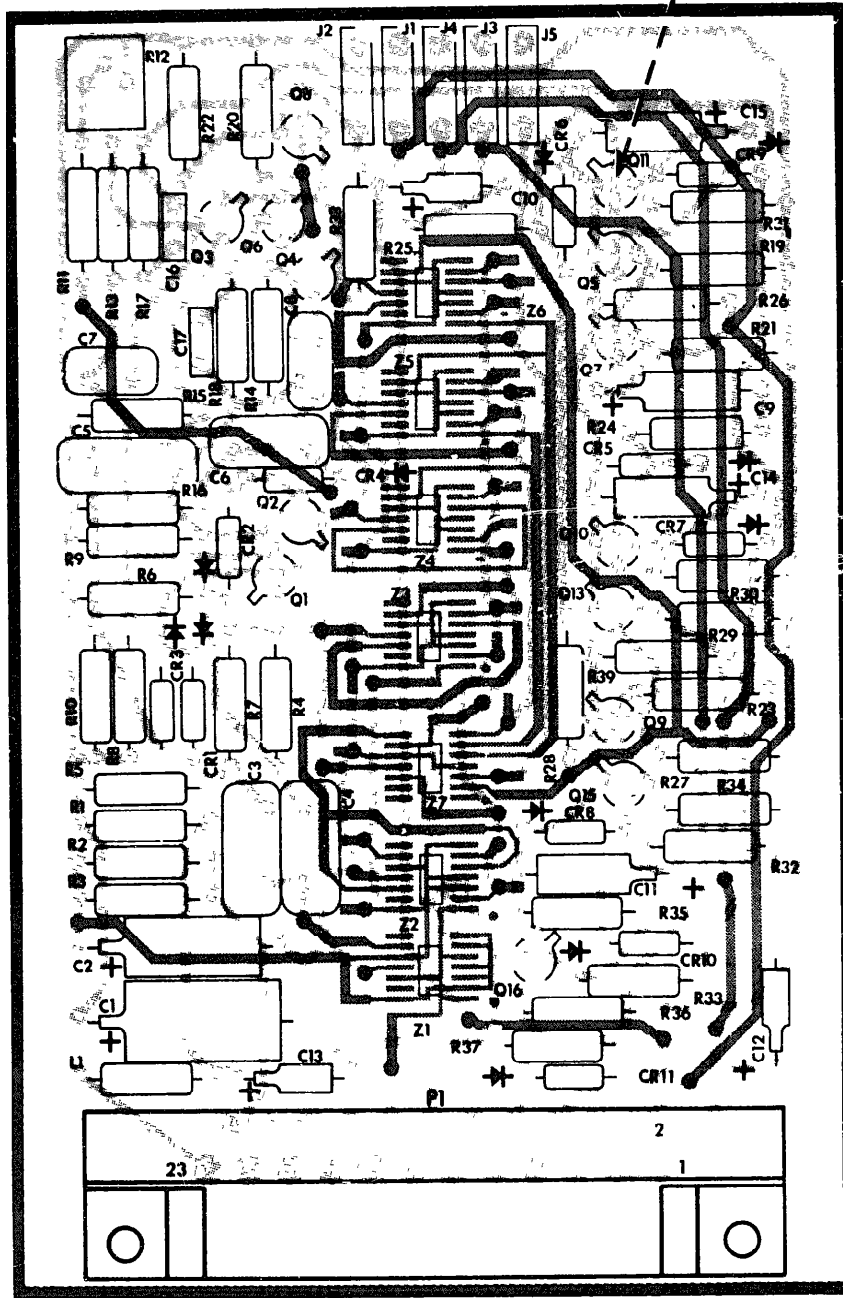

REF DES	ITEM NO	REF DES	ITEM NO	REF DES	ITEM NO	REF DES	ITEM NO	REF DES	ITEM NO	REF DES	ITEM NO
C1	1	CR4	10	E14	11	Q15	19	R19	25	R39	25
C2	2	CR5	10	J1	12	Q16	19	R20	25	Z1	29
C3	3	CR6	10	J2	13	R1	20	R21	22	Z2	29
C4	3	CR7	10	J3	14	R2	21	R22	22	Z3	29
C5	4	CR8	10	J4	15	R3	21	R23	24	Z4	29
C6	4	CR9	10	J5	16	R4	22	R24	25	Z5	29
C7	5	CR10	10	L1	17	R5	23	R25	25	Z6	29
C8	5	CR11	10	PI	18	R6	23	R26	25	Z7	30
C9	6	E1	11	Q1	19	R7	22	R27	28		
C10	7	E2	11	Q2	19	R8	24	R28	25		
C11	6	E3	11	Q3	19	R9	24	R29	22		
C12	7	E4	11	Q4	19	R10	25	R30	25		
C13	8	E5	11	Q5	19	R11	22	R31	25		
C14	6	E6	11	Q6	19	R12	26	R32	25		
C15	6	E7	11	Q7	19	R13	27	R33	25		
C16	9	E8	11	Q8	19	R14	27	R34	28		
C17	9	E9	11	Q9	19	R15	24	R35	25		
CR1	10	E10	11	Q10	19	R16	24	R36	25		
CR2	10	E11	11	Q11	19	R17	27	R37	22		
CR3	10	E12	11	Q13	19	R18	27	R38	22		
		E13	11								

LEGEND

BASING DIAGRAMS ARE SHOWN FROM THE TOP AS ON THE PART LOCATION DIAGRAM.

TRANSISTOR (Q)

OPERATIONAL AMPLIFIER (Z)

NOTE:

- 1 LIGHT SHADING INDICATES ETCHED SIDE
CIRCUIT PATTERN-DARK SHADING
INDICATES COMPONENT SIDE
PATTERN.
- 2 FOR COMPLETE REFERENCE
DESIGNATION PREFIX WITH
2A1A2
- 3 E1 THROUGH E14 ARE INSULATOR
DISKS MOUNTED UNDER THE
TRANSISTOR (Q1 THROUGH Q14,
Q13, Q15 AND Q16).

EL6625-1824-40P-TM-22

Figure 22 Generator, synchronous

SECTION II REPAIR PARTS LIST (CONTINUED)

(1) ILLUSTRATION		(2) SMR CODE	(3) FEDERAL STOCK NUMBER	(4) PART NUMBER	(5) FSCM	(6) DESCRIPTION	(7) UNIT OF MEAS	(8) QTY INC IN UNIT
(A) FIG NO.	(B) ITEM NO.							
23	12	PAD77	5961-342-9864	1N91L	81349	SEMICONDUCTOR DEVICE, DIODE	EA	6
23	13	PADZZ	5961-950-9887	1N917	81349	SEMICONDUCTOR DEVICE, DIODE	EA	2
23	14	PADZZ	5961-846-9157	1N759A	81349	SEMICONDUCTOR DEVICE, DIODE	EA	2
23	15	PAD7C	5961-054-0339	7717-19DAP	13103	INSULATOR, DISK	EA	
23	16	PAD7Z	5999-484-7515	7717-18N	13103	INSULATOR, DISK	EA	7
23	17	PADZZ	5935-131-9696	M39024-11-04	81349	JACK, TIP	EA	1
23	18	PADZZ	5935-131-9681	M39024-11-01	81349	JACK, TIP	EA	1
23	19	PADZZ	5935-131-9706	M39024-11-09	81349	JACK, TIP	EA	1
23	20	PADZZ	5935-131-9723	M39024-11-08	81349	JACK, TIP	EA	1
23	21	PADZZ	5935-131-9669	M39024-11-03	81349	JACK, TIP	EA	1
23	22	PAD7T	5905-771-1044	ME75-5425	96906	COIL, RADIO FREQUENCY	EA	1
23	23	PAD7E	5905-204-7825	DP002PL0AADP	97954	CONNECTOR, RECEPTACLE, ELECTRICAL	EA	1
23	24	PAD7T	5905-204-7807	DP002PL0A	81349	TRANSISTOR	EA	1
23	25	PAD7E	5905-204-7809	DP002PL0A	81349	TRANSISTOR	EA	1
23	26	PAD7E	5905-204-7807	DP002PL0A	81349	TRANSISTOR	EA	2
23	27	PADZZ	5905-957-8633	RN60D51R1F	81349	RESISTOR, FIXED, FILM	EA	2
23	28	PAD7Z	5905-008-3800	RN60D4752F	81349	RESISTOR, FIXED, FILM	EA	1
23	29	PAD7T	5905-983-6914	RN60D1009F	81349	RESISTOR, FIXED, FILM	EA	1
23	30	PADZZ	5905-778-4840	RN60D1401F	81349	RESISTOR, FIXED, FILM	EA	3
23	31	PADZZ	5905-892-6578	RN60D110F	81349	RESISTOR, FIXED, FILM	EA	1
23	32	PAD7T	5905-432-6410	RN60D1401F	81349	RESISTOR, FIXED, FILM	EA	7
23	33	PADZZ	5905-067-5576	RN60D4812F	81349	RESISTOR, FIXED, FILM	EA	1
23	34	PAD7Z	5905-204-7824	RN60D4709F	81349	RESISTOR, FIXED, FILM	EA	1
23	35	PAD7Z	5905-204-7811	RN60D4709F	81349	RESISTOR, VARIABLE, WIDEWIND	EA	1
23	36	PAD7E	5905-721-2348	RN60D9022F	81349	RESISTOR, FIXED, FILM	EA	1
23	37	PADZZ	5905-988-2313	RN60D101F	81349	RESISTOR, FIXED, FILM	EA	1
23	38	PAD7C	5905-732-3859	RN60D1809F	81349	RESISTOR, FIXED, FILM	EA	1
23	39	PAD7C	5905-138-1288	RN60D1022F	81349	RESISTOR, FIXED, FILM	EA	2
23	40	PADZZ	5905-984-7679	RN60D1213F	81349	RESISTOR, FIXED, FILM	EA	2
23	41	PADZZ	5905-451-7532	RN60D4991F	81349	RESISTOR, FIXED, FILM	EA	1
23	42	PADZZ	5905-069-3913	RN60D2710F	81349	RESISTOR, FIXED, FILM	EA	2
23	43	PAD7Z	5905-984-7681	RN60D2009F	81349	RESISTOR, FIXED, FILM	EA	1
23	44	PAD7C	5905-069-5846	RN60D3921F	81349	RESISTOR, FIXED, FILM	EA	1
23	45	PADZZ	5905-458-0773	RN60D8352F	81349	RESISTOR, FIXED, FILM	EA	1
23	46	PADZZ	5905-195-6379	RN60D1847F	81349	RESISTOR, FIXED, FILM	EA	1
23	47	PAD7C	5905-138-1285	RN60D2001F	81349	RESISTOR, FIXED, FILM	EA	1
23	48	PAD7C	5905-189-2454	RN60D1064F	81349	RESISTOR, FIXED, FILM	EA	1
23	49	PAD7Z	5962-148-2358	741009L	01096	INTEGRATED CIRCUIT, OPERATIONAL AMPLIFIER	EA	1
24	1	PAD7T	5910-210-8718	0006B103K	81349	GROUP PAIR: GENERATOR, WRITE HORIZONTAL SWEEP	EA	1
24	2	PADZZ	5910-113-5689	CSF13E476KI	81349	CAPACITOR, FIXED, ELECTROLYTIC	EA	1
24	3	PADZZ	5910-850-1205	LP9A1C104J	1884	CAPACITOR, FIXED, PLASTIC DIELECTRIC	EA	1
24	4	PADZZ	5910-410-9329	CM06FD102J03	81349	CAPACITOR, FIXED, MICA DIELECTRIC	EA	4

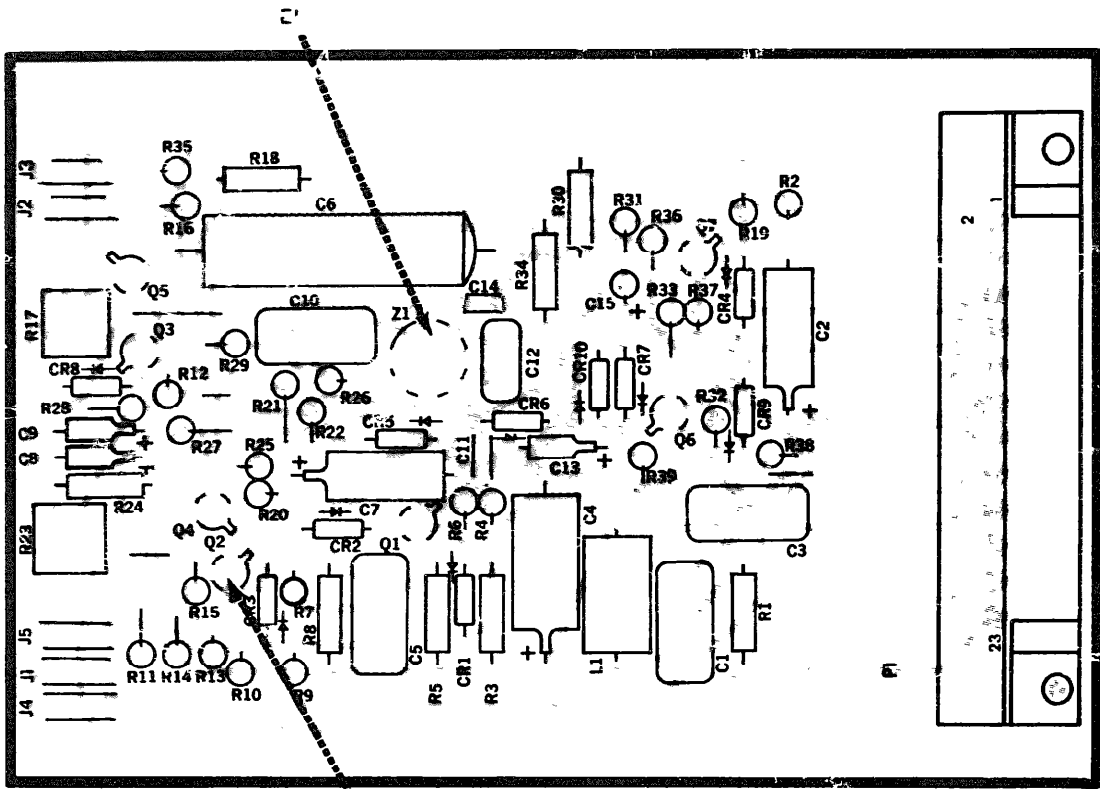

SEE NOTE 3

REF DES	ITEM NO	REF DES	ITEM NO	REF DES	ITEM NO	REF DES	ITEM NO	REF DES	ITEM NO	REF DES	ITEM NO	REF DES	ITEM NO
C1	1	C12	10	CR8	14	J1	17	Q5	25	R9	30	R20	38
C2	2	C13	11	CR9	12	J2	18	Q6	25	R10	29	R21	37
C3	1	C14	9	CR10	12	J3	19	Q7	26	R11	32	R22	39
C4	3	C15	7	E1	15	J4	20	R1	27	R12	33	R23	35
C5	4	CR1	12	E2	16	J5	21	R2	27	R13	34	R24	40
C6	5	CR2	12	E3	16	L1	22	R3	28	R14	32	R25	41
C7	6	CR3	12	E4	16	P1	23	R4	29	R15	32	R26	30
C8	7	CR4	13	E5	16	Q1	24	R5	30	R16	32	R27	40
C9	7	CR5	13	E6	16	Q2	24	R6	29	R17	35	R28	42
C10	8	CR6	14	E7	16	Q3	25	R7	31	R18	36	R29	39
C11	9	CR7	12	E8	16	Q4	26	R8	29	R19	37	R30	42

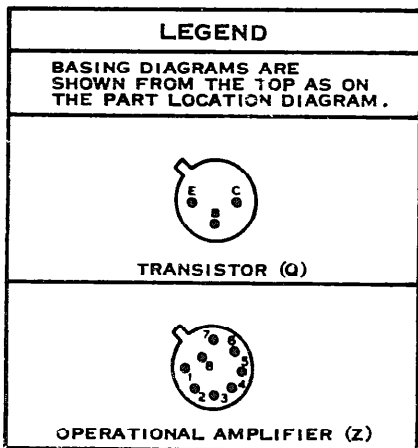

NOTE:

1. LIGHT SHADING INDICATES ETCHED SIDE CIRCUIT PATTERN-DARK SHADING INDICATES COMPONENT SIDE PATTERN.
2. FOR COMPLETE REFERENCE DESIGNATION PREFIX WITH 2A1A3
3. E1 IS AN INSULATOR DISK MOUNTED UNDER Z1; E2 THROUGH E8 ARE INSULATOR DISKS MOUNTED UNDER Q1 THROUGH Q7.

Figure 23 Generator read vertical sweep

SECTION II REPAIR PARTS LIST (CONTINUED)

(1) ILLUSTRATION		(2) SMR CODE	(3) FEDERAL STOCK NUMBER	(4) PART NUMBER	(5) FSCM	(6) DESCRIPTION	(7) UNIT OF MEAS	(8) USABLE ON CODE
(A) FIG NO.	(B) ITEM NO.							
24	5	PADZZ	5910-154-0547	CSP15F476KL	81349	CAPACITOR, FIXED, ELECTROLYTIC	EA	
24	6	PADZZ	5910-229-7757	LP9A10474J	01884	CAPACITOR, FIXED, PLASTIC DIELECTRIC	EA	
24	7	PADZZ	5910-079-5253	CM06FD472G03	81349	CAPACITOR, FIXED, MICA DIELECTRIC	EA	
24	8	PADZZ	5910-460-0869	CM05FD221J00	81349	CAPACITOR, FIXED, MICA DIELECTRIC	EA	
24	9	PADZZ	5961-995-2310	1N752A	81349	SEMICONDUCTOR DEVICE, DIODE	EA	
24	10	PADZZ	5961-821-2309	1N751A	81349	SEMICONDUCTOR DEVICE, DIODE	EA	
24	11	PADZZ	5961-842-9864	1N914	81349	SEMICONDUCTOR DEVICE, DIODE	EA	
24	12	PADZZ	5961-950-9887	1N827	81349	SEMICONDUCTOR DEVICE, DIODE	EA	
24	13	PADZZ	5961-836-6667	1N756	81349	SEMICONDUCTOR DEVICE, DIODE	EA	
24	14	PADZZ	5961-752-6121	1N753A	81349	SEMICONDUCTOR DEVICE, DIODE	EA	
24	15	PADZZ	5961-923-3940	1N825	81349	SEMICONDUCTOR DEVICE, DIODE	EA	
24	16	PADZZ	5961-054-0339	7717-19DAP	13103	INSULATOR, DISK	EA	
24	17	PADZZ	5999-484-5513	7717-12B	13103	INSULATOR, DISK	EA	
24	18	PADZZ	5935-131-9696	M39024-11-04	81349	JACK, TIP	EA	
24	19	PADZZ	5935-131-9681	M39024-11-02	81349	JACK, TIP	EA	
24	20	PADZZ	5935-131-9726	M39024-11-06	81349	JACK, TIP	EA	
24	21	PADZZ	5935-131-9728	M39024-11-08	81349	JACK, TIP	EA	
24	22	PADZZ	5935-131-9697	M39024-11-05	81349	JACK, TIP	EA	
24	23	PADZZ	5950-771-2089	MC75054-5	96906	COIL, RADIO FREQUENCY	EA	
24	24	PADZZ	5935-236-7731	UP0CS2423AACT	97954	CONNECTOR, RECEPTACLE, ELECTRICAL	EA	
24	25	PADZZ	5961-951-8757	2N2222A	81349	TRANSISTOR	EA	
24	26	PADZZ	5961-913-1747	2N2907	81349	TRANSISTOR	EA	
24	27	PADZZ	5961-226-8579	2N930	81349	TRANSISTOR	EA	
24	28	PADZZ	5905-758-2063	RN60D2210F	81349	RESISTOR, FIXED, FILM	EA	
24	29	PADZZ	5905-432-6410	RN60D1001F	81349	RESISTOR, FIXED, FILM	EA	
24	30	PADZZ	5905-983-6914	RN60D1002F	81349	RESISTOR, FIXED, FILM	EA	
24	31	PADZZ	5905-138-1285	RN60D2001F	81349	RESISTOR, FIXED, FILM	EA	
24	32	PADZZ	5905-451-7532	RN60D4991F	81349	RESISTOR, FIXED, FILM	EA	
24	33	PADZZ	5905-721-2385	RN60D3322F	81349	RESISTOR, FIXED, FILM	EA	
24	34	PADZZ	5905-487-2151	RT24C2P100	81349	RESISTOR, VARIABLE, WIREWOUND	EA	
24	35	PADZZ	5905-208-3800	RN60D4750F	81349	RESISTOR, FIXED, FILM	EA	
24	36	PADZZ	5905-957-8633	RN60D54R1F	81349	RESISTOR, FIXED, FILM	EA	
24	37	PADZZ	5905-892-6578	RN60D212F	81349	RESISTOR, FIXED, FILM	EA	
24	38	PADZZ	5905-984-7681	RN60D2002F	81349	RESISTOR, FIXED, FILM	EA	
24	39	PADZZ	5905-184-7794	RN60C8251F	81349	RESISTOR, FIXED, FILM	EA	
24	40	PADZZ	5905-104-0922	RT24C2P502	81349	RESISTOR, VARIABLE, WIREWOUND	EA	
24	41	PADZZ	5905-142-0901	RN60E2000F	81349	RESISTOR, FIXED, FILM	EA	
24	42	PADZZ	5905-758-4840	RN60D1501F	81349	RESISTOR, FIXED, FILM	EA	
24	43	PADZZ	5905-079-6336	PT24C2P100	81349	RESISTOR, VARIABLE, WIREWOUND	EA	
24	44	PADZZ	5905-192-3479	RN60E9001F	81349	RESISTOR, FIXED, FILM	EA	
24	45	PADZZ	5962-148-2858	SN52709L	01295	INTEGRATED CIRCUIT, OPERATIONAL AMPLIFIER	EA	
24	46	PADZZ	5962-248-2336	SN52709L	01295	INTEGRATED CIRCUIT, DIFFERENTIATING COMPARATOR	EA	

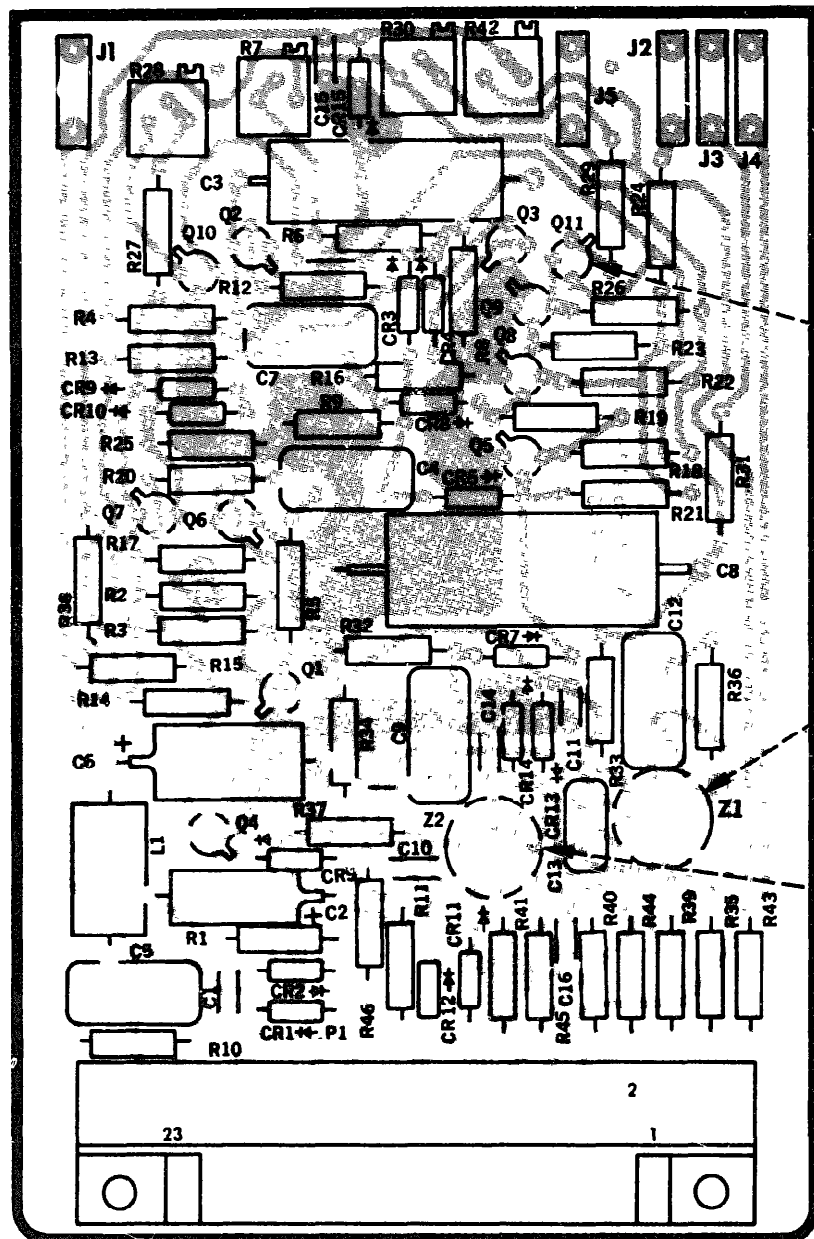

REF DES	ITEM NO	REF DES	ITEM NO	REF DES	ITEM NO	REF DES	ITEM NO
C1	1	E10	17	R19	38	R29	30
C2	2	E11	17	R20	38	R30	40
C3	3	E12	17	R21	38	R31	29
C4	4	E13	17	R22	31	R32	30
C5	4	J1	18	R23	35	R33	32
C6	5	J2	19	R24	29	R34	41
C7	4	J3	20	R25	29	R35	30
C8	6	J4	21	R26	30	R36	42
C9	4	J5	22	R27	39	R37	41
C10	1	L1	23	R28	40	R38	29
C11	1	P1	24	Z1	45	Z2	46
C12	7	Q1	25				
C13	8	Q2	26				
C14	1	Q3	26				
C15	1	Q4	25				
C16	1	Q5	26				
CR1	9	Q6	25				
CR2	10	Q7	26				
CR3	11	Q8	26				
CR4	11	Q9	26				
CR5	11	Q10	26				
CR6	11	Q11	27				
CR7	11	R1	28				
CR8	11	R2	29				
CR9	12	R3	30				
CR10	13	R4	31				
CR11	14	R5	32				
CR12	14	R6	33				
CR13	14	R7	34				
CR14	14	R8	35				
CR15	15	R9	30				
E1	16	R10	36				
E2	16	R11	30				
E3	17	R12	37				
E4	17	R13	31				
E5	17	R14	38				
E6	17	R15	29				
E7	17	R16	30				
E8	17	R17	29				
E9	17	R18	31				

SEE NOTE 3

NOTE:

1. LIGHT SHADING INDICATES ETCHED SIDE CIRCUIT PATTERN-DARK SHADING INDICATES COMPONENT SIDE PATTERN.
2. FOR COMPLETE REFERENCE DESIGNATION PREFIX WITH "ZATA".
3. EACH TRANSISTOR (Q1 THROUGH Q11) IS MOUNTED ON AN INSULATOR DISC (E3 THROUGH E13).

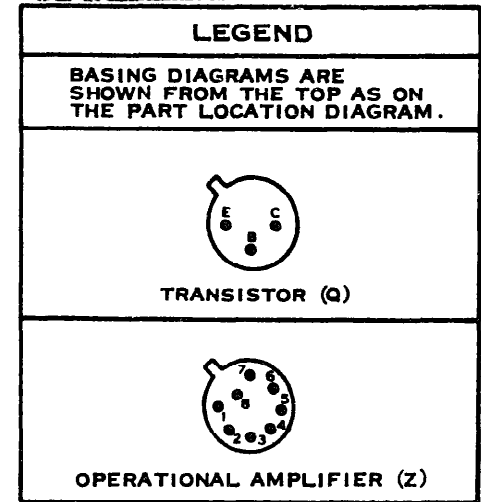

EL 6625-1824-40P-TM-24

Figure 24 Generator, write horizontal sweep

SECTION II REPAIR PARTS LIST (CONTINUED)

(1) ILLUSTRATION		(2) SMR CODE	(3) FEDERAL STOCK NUMBER	(4) PART NUMBER	(5) FSCM	(6) DESCRIPTION	(7) UNIT OF MEAS	USABLE ON CODE
(A) FIG NO.	(B) ITEM NO.							
GROUP 2A1A5 SLEW, WRITE HORIZONTAL								
AND FIELD-OF-VIEW ADFF								
25	1	PADZZ	5910-410-9329	CM06FD102J03	81349	CAPACITOR, FIXED, MICA DIELECTRIC	EA	3
25	2	PADZZ	5910-936-1332	CSR13F685KL	81349	CAPACITOR, FIXED, ELECTROLYTIC	EA	2
25	3	PADZZ	5910-481-1626	CM06FD470J03	81349	CAPACITOR, FIXED, MICA DIELECTRIC	EA	1
25	4	PADZZ	5910-460-0869	CM05FD221J03	81349	CAPACITOR, FIXED, MICA DIELECTRIC	FA	3
25	5	PADZZ	5910-010-8718	CK06BX103K	81349	CAPACITOR, FIXED, CERAMIC DIELECTRIC	EA	7
25	6	PADZZ	5910-934-2564	CSR13C157KL	81349	CAPACITOR, FIXED, ELECTROLYTIC	EA	2
25	7	PADZZ	5910-410-734	CM06FD390J03	81349	CAPACITOR, FIXED, MICA DIELECTRIC	EA	2
25	8	PADZZ	5910-007-2000	CSR13B685KL	81349	CAPACITOR, FIXED, ELECTROLYTIC	EA	2
25	9	PADZZ	5910-717-3539	CM06FD332J03	81349	CAPACITOR, FIXED, MICA DIELECTRIC	EA	1
25	10	PADZZ	5910-236-8740	CSR13L256KL	81349	CAPACITOR, FIXED, ELECTROLYTIC	EA	
25	11	PADZZ	5910-410-1047	CM06FD510J03	81349	CAPACITOR, FIXED, MICA DIELECTRIC	FA	2
25	12	PADZZ	5961-846-9157	1N759A	81349	SEMICONDUCTOR DEVICE, DIODE	FA	6
25	13	PADZZ	5961-842-9864	1N91L	81349	SEMICONDUCTOR DEVICE, DIODE	EA	15
25	14	PADZZ	5961-087-6047	1N645	81349	SEMICONDUCTOR DEVICE, DIODE	EA	1
25	15	PADZZ	5961-752-6121	1N753A	81349	SEMICONDUCTOR DEVICE, DIODE	EA	1
25	16	PADZZ	5999-484-5513	7717-18N	13103	INSULATOR, DISK	EA	8
25	17	PADZZ	5961-054-0339	7717-19DAP	13103	INSULATOR, DISK	EA	2
25	18	PADZZ	5961-058-8952	7717-21DAP	13103	INSULATOR, STANDOFF	EA	1
25	19	PADZZ	5935-131-9696	M39024-11-04	81349	JACK, TIP	EA	1
25	20	PADZZ	5935-131-9681	M39024-11-02	81349	JACK, TIP	EA	1
25	21	PADZZ	5935-131-9726	M39024-11-06	81349	JACK, TIP	EA	1
25	22	PADZZ	5935-131-9728	M39024-11-08	81349	JACK, TIP	EA	1
25	23	PADZZ	5935-131-9693	M39024-11-03	81349	JACK, TIP	EA	1
25	24	PADZZ	5950-727-0680	MS75052-5	96906	COIL, RADIO FREQUENCY	EA	2
25	25	PADZZ	5935-256-0730	UPCCSGM23AACS	97954	CONNECTOR, RECEPTACLE, ELECTRICAL	EA	1
25	26	PADZZ	5961-890-9867	2N4856	81349	TRANSISTOR	EA	2
25	27	PADZZ	5961-951-8757	2N2222A	81349	TRANSISTOR	EA	4
25	28	PADZZ	5961-226-8579	2N930	81349	TRANSISTOR	EA	1
25	29	PADZZ	5961-925-3777	2N2907A	81349	TRANSISTOR	EA	1
25	30	PADZZ	5905-078-8365	RN60D5112F	81349	RESISTOR, FIXED, FILM	EA	1
25	31	PADZZ	5905-957-8633	RN60D51R1F	81349	RESISTOR, FIXED, FILM	EA	2
25	32	PADZZ	5905-758-4840	RN60D1901F	81349	RESISTOR, FIXED, FILM	EA	2
25	33	PADZZ	5905-432-6411	RN60D3320F	81349	RESISTOR, FIXED, FILM	EA	3
25	34	PADZZ	5905-407-2160	RN60C1003F	81349	RESISTOR, FIXED, FILM	EA	2
25	35	PADZZ	5905-189-2454	RN60D1702F	81349	RESISTOR, FIXED, FILM	EA	4
25	36	PADZZ	5905-025-5987	RN60D2491F	81349	RESISTOR, FIXED, FILM	EA	2
25	37	PADZZ	5905-138-1285	RN60D2001F	81349	RESISTOR, FIXED, FILM	EA	3
25	38	PADZZ	5905-983-6914	RN60D1702F	81349	RESISTOR, FIXED, FILM	EA	2
25	39	PADZZ	5905251-7581	RT24C2P201	81349	RESISTOR, VARIABLE, WIREWOUND	EA	2
25	40	PADZZ	5905-069-3913	RN60D2740F	81349	RESISTOR, FIXED, FILM	EA	3
25	41	PADZZ	5905-689-1966	RN60D6810F	81349	RESISTOR, FIXED, FILM	EA	2

SECTION II REPAIR PARTS LIST (CONTINUED)

(1) ILLUSTRATION		(2) SMR CODE	(3) FEDERAL STOCK NUMBER	(4) PART NUMBER	(5) FSCM	(6) DESCRIPTION	(7) UNIT OF MEAS	(8) QTY INC IN UNIT
(A) FIG NO.	(B) ITEM NO.							
25	42	PADZZ	5905-767-0983	RN60D3242F	81349	RESISTOR, FIXED, FILM	EA	2
25	43	PADZZ	5905-892-6578	RN60D1212F	81349	RESISTOR, FIXED, FILM	EA	2
25	44	PADZZ	5905-452-0773	RN60D8250F	81349	RESISTOR, FIXED, FILM	EA	1
25	45	PADZZ	5905-758-2063	RN60D2270F	81349	RESISTOR, FIXED, FILM	EA	1
25	46	PADZZ	5905-242-2640	FBR55L10001QM	81349	RESISTOR, FIXED, WIREWOUND	EA	1
25	47	PADZZ	5905-242-2047	RBR55L12001QM	81349	RESISTOR, FIXED, WIREWOUND	EA	1
25	48	PADZZ	5905-242-2048	FBR55L32801QM	81349	RESISTOR, FIXED, WIREWOUND	EA	1
25	49	PADZZ	5905-432-6410	RN60D1001F	81349	RESISTOR, FIXED, FILM	EA	4
25	50	PADZZ	5905-984-7681	RN60D1002F	81349	RESISTOR, FIXED, FILM	EA	1
25	51	PADZZ	5905-451-7522	RN60D1112F	81349	RESISTOR, FIXED, FILM	EA	2
25	52	PADZZ	5905-489-2151	RN60D12103	81349	RESISTOR, VARIABLE, WIREWOUND	EA	1
25	53	PADZZ	5905-452-0773	RN60D2250F	81349	RESISTOR, FIXED, FILM	EA	1
25	54	PADZZ	5905-142-0901	RN60D1000F	81349	RESISTOR, FIXED, FILM	EA	1
25	55	PADZZ	5905-42-2640	FBR55L10002QM	81349	RESISTOR, FIXED, WIREWOUND	EA	1
25	56	PADZZ	5905-165-3105	RN60D1422F	81349	RESISTOR, FIXED, FILM	EA	2
25	57	PADZZ	5905-752-360	RN60D4641F	81349	RESISTOR, FIXED, FILM	EA	2
25	58	PADZZ	5905-432-0468	RN60D3923F	81349	RESISTOR, FIXED, FILM	EA	1
25	59	PADZZ	5962-148-2858	CM52709L	01796	INTEGRATED CIRCUIT, OPERATIONAL AMPLIFIER	EA	1
25	60	PADZZ	5962-233-3948	CM52711L	01796	INTEGRATED CIRCUIT, DIFFERENTIATING COMPARATOR GROUP 2A46 AMPLIFIER, WRITE VIDEO	EA	1
26	1	PADZZ	5910-936-1332	CM313F634KL	81349	CAPACITOR, FIXED, ELECTROLYTIC	EA	3
26	2	PADZZ	5910-010-8718	CM06B4103K	81349	CAPACITOR, FIXED, CERAMIC DIELECTRIC	EA	12
26	3	PADZZ	5910-460-0869	CM05FD101J03	81349	CAPACITOR, FIXED, MICA DIELECTRIC	EA	1
26	4	PADZZ	5910-410-9329	CM06FD102J03	81349	CAPACITOR, FIXED, MICA DIELECTRIC	EA	1
26	5	PADZZ	5910-460-1047	CM05FD101J03	81349	CAPACITOR, FIXED, MICA DIELECTRIC	EA	1
26	6	PADZZ	5910-082-4898	CM07FD101J03	81349	CAPACITOR, FIXED, MICA DIELECTRIC	EA	1
26	7	PADZZ	5910-487-8424	CM05FD391J03	81349	CAPACITOR, FIXED, MICA DIELECTRIC	EA	1
26	8	PADZZ	5961-087-6047	1N645	81349	SEMICONDUCTOR DEVICE, DIODE	EA	4
26	9	PADZZ	5961-852-7549	1N754A	81349	SEMICONDUCTOR DEVICE, DIODE	EA	1
26	10	PADZZ	5961-752-6121	1N753A	81349	SEMICONDUCTOR DEVICE, DIODE	EA	1
26	11	PADZZ	5961-846-9157	1N759A	81349	SEMICONDUCTOR DEVICE, DIODE	EA	1
26	12	PADZZ	5961-919-4224	7717-44N	13103	INSULATOR, DISK	EA	6
26	13	PADZZ	5961-054-0339	7717-19DAP	13103	INSULATOR, DISK	EA	4
26	14	XBHFF	5961-951-5474	10105DAP	07027	INSULATOR, PLATE	EA	1
26	15	PADZZ	5935-131-9696	M39024-11-04	81349	JACK, TIP	EA	1
26	16	PADZZ	5935-131-9693	M39024-11-03	81349	JACK, TIP	EA	1
26	17	PADZZ	5945-851-2878	EA1AD055	35324	RELAY, ARMATURE	EA	1
26	18	PADZZ	5935-236-7833	UPCC9GM3AADK	97954	CONNECTOR, RECEPTACLE, ELECTRICAL	EA	1
26	19	PADZZ	5961-949-6563	2N2432	81349	TRANSISTOR	EA	1
26	20	PADZZ	5961-890-9867	2N4856	81349	TRANSISTOR	EA	1
26	21	PADZZ	5961-913-1747	2N7907	81349	TRANSISTOR	EA	1
26	22	PADZZ	5961-951-8757	2N7907A	81349	TRANSISTOR	EA	1
26	23	PADZZ	5905-957-8633	RN60D51R1F	81349	RESISTOR, FIXED, FILM	EA	6

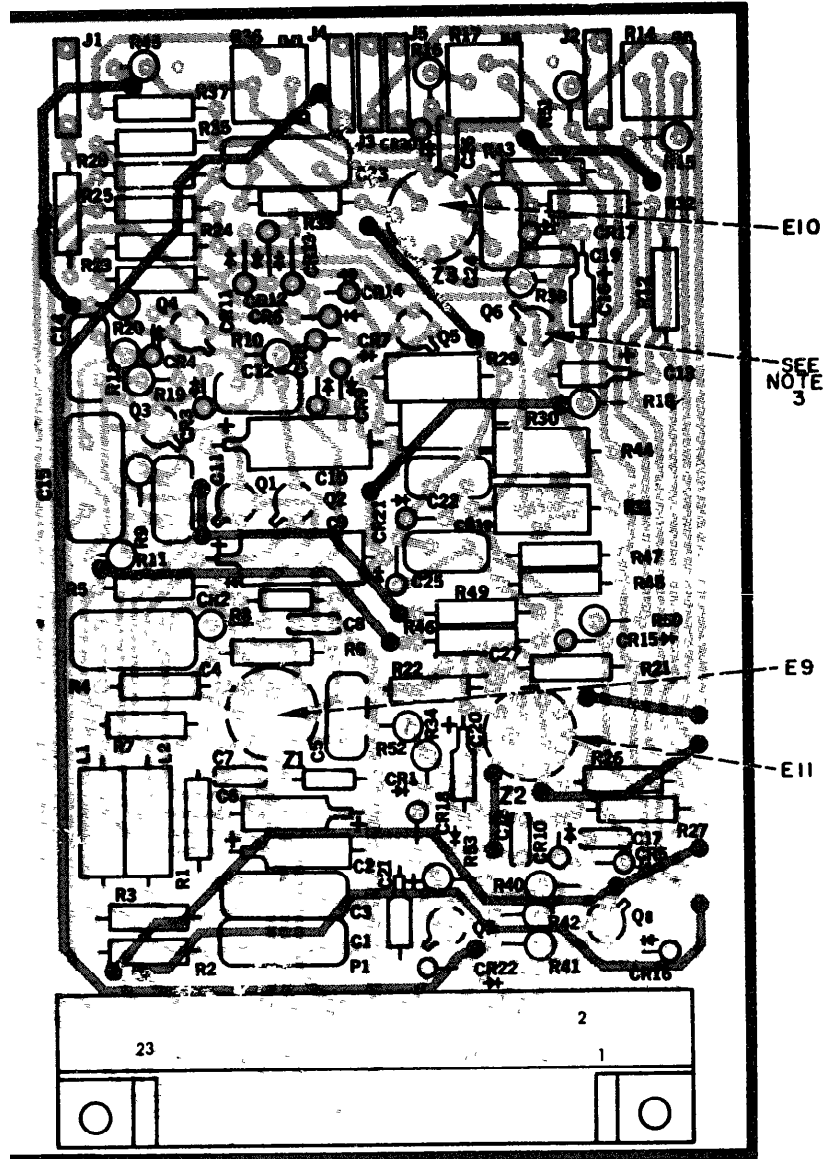

REF DES	ITEM NO	REF DES	ITEM NO	REF DES	ITEM NO	REF DES	ITEM NO
C1	1	CR13	13	R3	31	R42	49
C2	2	CR14	13	R4	32	R43	54
C3	1	CR15	13	R5	33	R44	55
C4	3	CR16	13	R6	34	R45	40
C5	4	CR17	12	R7	33	R46	56
C6	2	CR18	13	R8	34	R47	57
C7	5	CR19	13	R9	35	R48	57
C8	5	CR20	12	R10	35	R49	56
C9	6	CR21	13	R11	36	R50	49
C10	6	CR22	13	R12	37	R51	49
C11	7	E1	16	R13	38	R52	58
C12	7	E2	16	R14	39	R53	35
C13	8	E3	16	R15	40	Z1	59
C14	4	E4	16	R16	40	Z2	60
C15	9	E5	16	R17	39	Z3	59
C16	8	E6	16	R18	37		
C17	5	E7	16	R19	38		
C18	5	E8	16	R20	36		
C19	5	E9	17	R21	41		
C20	10	E10	17	R22	41		
C21	10	E11	18	R23	42		
C22	11	J1	19	R24	42		
C23	1	J2	20	R25	43		
C24	4	J3	21	R26	44		
C25	11	J4	22	R27	45		
C26	5	J5	23	R28	43		
C27	5	L1	24	R29	46		
CR1	12	L2	24	R30	47		
CR2	12	P1	25	R31	48		
CR3	13	Q1	26	R32	33		
CR4	14	Q2	26	R33	49		
CR5	15	Q3	27	R34	50		
CR6	13	Q4	27	R35	51		
CR7	13	Q5	27	R36	52		
CR8	13	Q6	27	R37	35		
CR9	13	Q7	28	R38	51		
CR10	12	Q8	29	R39	32		
CR11	13	R1	30	R40	53		
CR12	13	R2	31	R41	37		

LEGEND

BASING DIAGRAMS ARE SHOWN FROM THE TOP AS ON THE PART LOCATION DIAGRAM.

TRANSISTOR (Q)

OPERATIONAL AMPLIFIER (Z)

FIELD EFFECT TRANSISTOR (FET) (Q)

- NOTE:**
1. LIGHT SHADING INDICATES ETCHED SIDE CIRCUIT PATTERN—DARK SHADING INDICATES COMPONENT SIDE PATTERN.
 2. FOR COMPLETE REFERENCE DESIGNATION PREFIX WITH 2A1A5.
 3. EACH TRANSISTOR (Q1 THROUGH Q8) IS MOUNTED ON AN INSULATOR DISC (E1 THROUGH E8).

Figure 25 Slew, write horizontal and field-of-view adder

SECTION II REPAIR PARTS LIST (CONTINUED)

(1) ILLUSTRATION		(2) SMR CODE	(3) FEDERAL STOCK NUMBER	(4) PART NUMBER	(5) FSCM	(6) DESCRIPTION	USABLE ON CODE	(7) UNIT OF MEAS	(8) QTY INC IN UNIT
(A) FIG NO.	(B) ITEM NO.								
26	24	PADZZ	5905-211-0230	RN60D2211F	81349	RESISTOR, FIXED, FILM		EA	2
26	25	PADZZ	5905-261-7693	RN60D1621F	81349	RESISTOR, FIXED, FILM		EA	4
26	26	PADZZ	5905-988-2310	RN60D1000F	81349	RESISTOR, FIXED, FILM		EA	2
26	27	PADZZ	5905-104-0922	RT24C2P502	81349	RESISTOR, VARIABLE, WIREWOUND		EA	2
26	28	PADZZ	5905-142-0931	RN60D5111F	81349	RESISTOR, FIXED, FILM		EA	7
26	29	PADZZ	5905-983-6914	RN60D1002F	81349	RESISTOR, FIXED, FILM		EA	3
26	30	PADZZ	5905-189-2467	RN60D3011F	81349	RESISTOR, FIXED, FILM		EA	3
26	31	PADZZ	5905-142-0901	RN60D2000F	81349	RESISTOR, FIXED, FILM		EA	3
26	32	PADZZ	5905-243-5622	RN60D3010F	81349	RESISTOR, FIXED, FILM		EA	1
26	33	PADZZ	5905-227-5072	RN60D3920F	81349	RESISTOR, FIXED, FILM		EA	3
26	34	PADZZ	5905-763-6653	RN60D75R0F	81349	RESISTOR, FIXED, FILM		EA	2
26	35	PADZZ	5905-138-1285	RN60D2001F	81349	RESISTOR, FIXED, FILM		EA	2
26	36	PADZZ	5905-682-7773	RN60D4990F	81349	RESISTOR, FIXED, FILM		EA	1
26	37	PADZZ	5905-763-9309	RN60D39R2F	81349	RESISTOR, FIXED, FILM		EA	1
26	38	PADZZ	5905-233-7141	RN60D2741F	81349	RESISTOR, FIXED, FILM		EA	1
26	39	PADZZ	5905-195-6377	RN60D1502F	81349	RESISTOR, FIXED, FILM		EA	1
26	40	PADZZ	5905-432-6410	RN60D1001F	81349	RESISTOR, FIXED, FILM		EA	3
26	41	PADZZ	5905-451-7534	RN60D7500F	81349	RESISTOR, FIXED, FILM		EA	1
26	42	PADZZ	5905-452-0743	RN60D1210F	81349	RESISTOR, FIXED, FILM		EA	1
26	43	PADZZ	5905-110-0950	RT24C2W501	81349	RESISTOR, VARIABLE, WIREWOUND		EA	2
26	44	PADZZ	5962-248-2336	SN52710L	01295	INTEGRATED CIRCUIT, DIFFERENTIATING COMPARATOR		EA	2
26	45	PADZZ	5962-245-5325	SN52702L	01295	INTEGRATED CIRCUIT, OPERATIONAL AMPLIFIER		EA	2
						GROUP 2A1A7 GENERATOR, VELOCITY/HEIGHT			
						CLOCK PULSE			
27	1	PADZZ	5910-010-8718	CK06BX103K	81349	CAPACITOR, FIXED, CERAMIC DIELECTRIC		EA	2
27	2	PADZZ	5910-481-1626	CM06FD472J03	81349	CAPACITOR, FIXED, MICA DIELECTRIC		EA	1
27	3	PADZZ	5910-460-0869	CM05FD221J03	81349	CAPACITOR, FIXED, MICA DIELECTRIC		EA	1
27	4	PADZZ	5910-229-7757	LP9A1C474J	01884	CAPACITOR, FIXED, PLASTIC DIELECTRIC		EA	1
27	5	PADZZ	5910-410-9329	CM06FD102J03	81349	CAPACITOR, FIXED, MICA DIELECTRIC		EA	5
27	6	PADZZ	5910-007-2003	CSR13E156KL	81349	CAPACITOR, FIXED, ELECTROLYTIC		EA	3
27	7	PADZZ	5910-777-6919	CM07FD103J03	81349	CAPACITOR, FIXED, MICA DIELECTRIC		EA	1
27	8	PADZZ	5910-154-0547	CSR13F476KL	81349	CAPACITOR, FIXED, ELECTROLYTIC		EA	1
27	9	PADZZ	5910-725-4794	CM06FD222J03	81349	CAPACITOR, FIXED, MICA DIELECTRIC		EA	1
27	10	PADZZ	5910-913-1096	CM07FD163J03	81349	CAPACITOR, FIXED, MICA DIELECTRIC		EA	1
27	11	PADZZ	5961-846-9157	1N759A	81349	SEMICONDUCTOR DEVICE, DIODE		EA	2
27	12	PADZZ	5961-821-2309	1N751A	81349	SEMICONDUCTOR DEVICE, DIODE		EA	1
27	13	PADZZ	5961-995-2310	1N752A	81349	SEMICONDUCTOR DEVICE, DIODE		EA	1
27	14	PADZZ	5961-842-9864	1N914	81349	SEMICONDUCTOR DEVICE, DIODE		EA	7
27	15	PADZZ	5999-484-5513	7717-18N	13103	INSULATOR, DISK		EA	14
27	16	PADZZ	5961-054-0339	7717-19DAP	13103	INSULATOR, DISK		EA	1
27	17	PADZZ	5935-131-9696	M39024-11-04	81349	JACK, TIP		EA	1
27	18	PADZZ	5935-131-9681	M39024-11-02	81349	JACK, TIP		EA	1
27	19	PADZZ	5935-131-9726	M39024-11-06	81349	JACK, TIP		EA	1

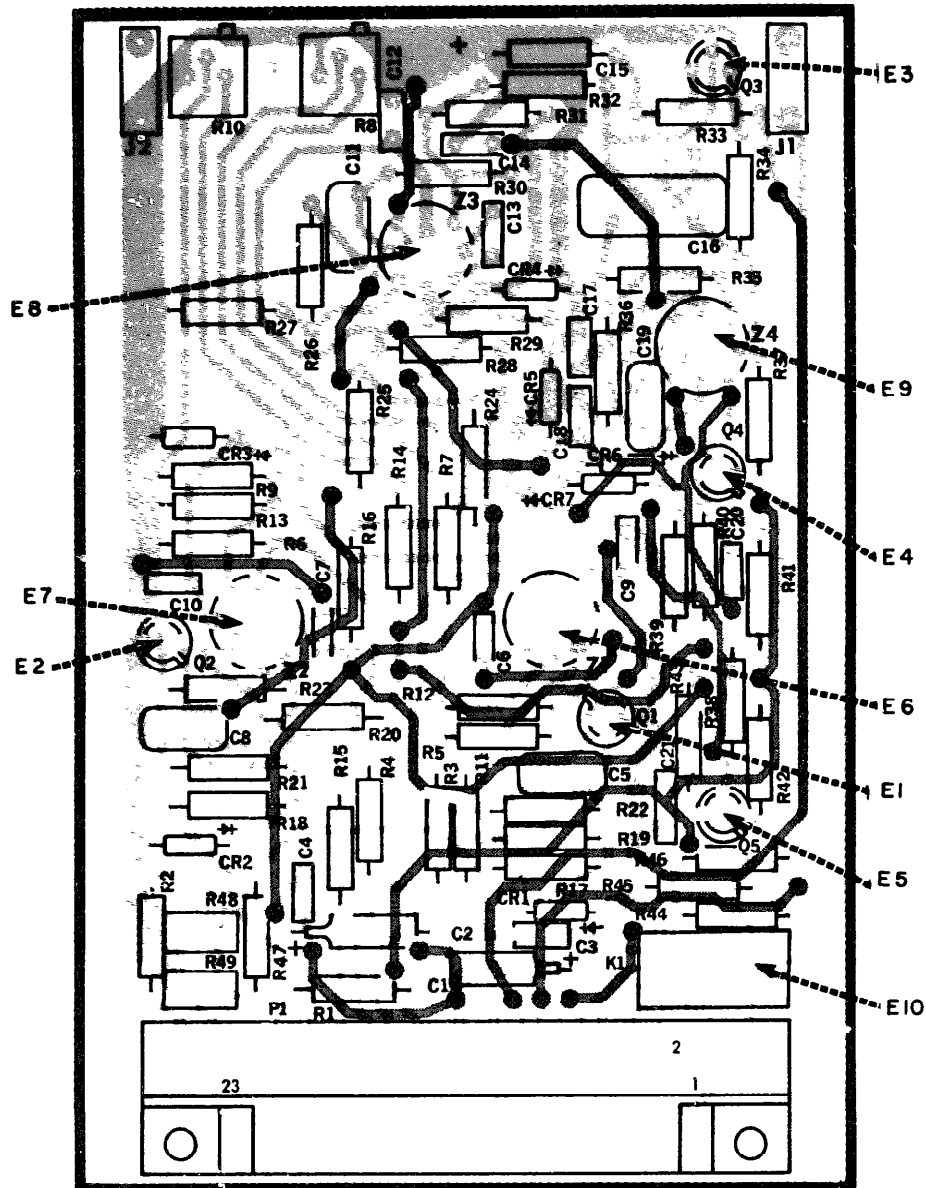

REF DES	ITEM NO	REF DES	ITEM NO	REF DES	ITEM NO
C1	1	E7	I3	R22	33
C2	1	E8	I3	R23	33
C3	2	E9	I3	R24	28
C4	2	E10	I4	R25	28
C5	3	J1	I5	R26	31
C6	2	J2	I6	R27	28
C7	2	K1	I7	R28	34
C8	3	P1	I8	R29	33
C9	2	Q1	I9	R30	29
C10	2	Q2	I9	R31	35
C11	4	Q3	I9	R32	28
C12	2	Q4	I9	R33	35
C13	5	Q5	I9	R34	36
C14	2	R1	I23	R35	37
C15	1	R2	I23	R36	38
C16	6	R3	I24	R37	39
C17	2	R4	I24	R38	28
C18	2	R5	I25	R39	30
C19	7	R6	I25	R40	40
C20	2	R7	I26	R41	23
C21	2	R8	I27	R42	23
CR1	8	R9	I26	R43	40
CR2	8	R10	I27	R44	41
CR3	9	R11	I28	R45	23
CR4	10	R12	I25	R46	40
CR5	11	R13	I25	R47	42
CR6	8	R14	I29	R48	43
CR7	8	R15	I28	R49	43
E1	12	R16	I29	Z1	44
E2	12	R17	I30	Z2	44
E3	12	R18	I30	Z3	45
E4	12	R19	I31	Z4	45
E5	12	R20	I32		
E6	13	R21	I31		

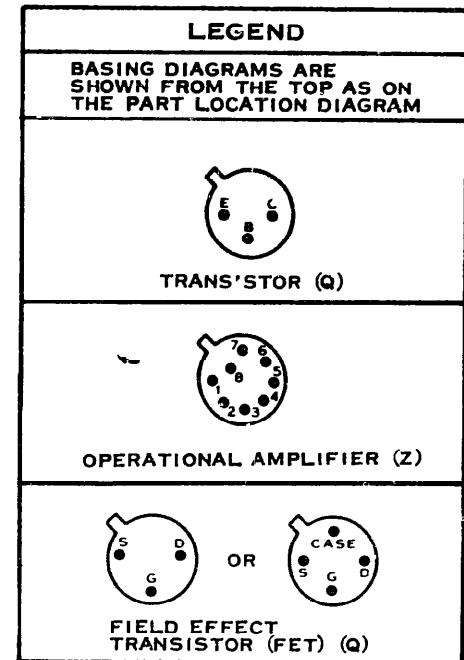

NOTE:

1. BASING DIAGRAMS FOR RELAYS ARE ILLUSTRATED ON THE RELAY CASE.
2. LIGHT SHADING INDICATES ETCHED SIDE CIRCUIT PATTERN—DARK SHADING INDICATES COMPONENT SIDE PATTERN.
3. FOR COMPLETE REFERENCE DESIGNATION PREFIX WITH, 2A1A6.
4. INSULATOR DISKS (E1 THROUGH E10) ARE LOCATED UNDER THE COMPONENTS AS INDICATED

Figure 26. Amplifier, write video

SECTION II REPAIR PARTS LIST (CONTINUED)

(1) ILLUSTRATION		(2) SMR CODE	(3) FEDERAL STOCK NUMBER	(4) PART NUMBER	(5) FSCM	(6) DESCRIPTION	(7) UNIT OF MEAS	(8) QTY INC IN UNIT
(A) FIG NO.	(B) ITEM NO.							
27	20	PADZZ	5935-131-9693	M39024-11-03	81349	JACK, TIP	EA	1
27	21	PADZZ	5950-771-2089	MS75054-5	96906	COIL, RADIO FREQUENCY	EA	2
27	22	PADZZ	5935-256-0753	UPCCSGM23AADF	97954	CONNECTOR RECEPTACLE, ELECTRICAL	EA	1
27	23	PADZZ	5961-951-8757	2N2222A	81349	TRANSISTOR	EA	10
27	24	PADZZ	5961-572-4284	2N3980	81349	TRANSISTOR	EA	1
27	25	PADZZ	5961-913-1747	2N2930	81349	TRANSISTOR	EA	2
27	26	PADZZ	5961-949-6563	2N2432	81349	TRANSISTOR	EA	1
27	27	PADZZ	5905-138-1285	RN60D2001F	81349	RESISTOR, FIXED, FILM	EA	1
27	28	PADZZ	5905-079-6336	RT24C2P100	81349	RESISTOR, VARIABLE, WIREWOUND	EA	1
27	29	PADZZ	5905-432-6410	RN60D1001F	81349	RESISTOR, FIXED, FILM	EA	6
27	30	PADZZ	5905-225-5988	RN60D3321F	81349	RESISTOR, FIXED, FILM	EA	2
27	31	PADZZ	5905-142-0901	RN60D2000F	81349	RESISTOR, FIXED, FILM	EA	1
27	32	PADZZ	5905-489-2151	RT24C2P100	81349	RESISTOR, VARIABLE, WIREWOUND	EA	1
27	33	PADZZ	5905-159-24754	RN60D1004F	81349	RESISTOR, FIXED, FILM	EA	1
27	34	PADZZ	5905-194-1695	RN60D4751F	81349	RESISTOR, FIXED, FILM	EA	4
27	35	PADZZ	5905-758-4840	RN60D1501F	81349	RESISTOR, FIXED, FILM	EA	3
27	36	PADZZ	5905-101-2326	RN60D2430F	81349	RESISTOR, FIXED, FILM	EA	1
27	37	PADZZ	5905-957-8633	RN60D51R1F	81349	RESISTOR, FIXED, FILM	EA	2
27	38	PADZZ	5905-192-3458	RN60D6812F	81349	RESISTOR, FIXED, FILM	EA	1
27	39	PADZZ	5905-195-6377	RN60D1502F	81349	RESISTOR, FIXED, FILM	EA	2
27	40	PADZZ	5905-758-2063	RN60D2210F	81349	RESISTOR, FIXED, FILM	EA	1
27	41	PADZZ	5905-211-0230	RN60D2211F	81349	RESISTOR, FIXED, FILM	EA	1
27	42	PADZZ	5905-983-6914	RN60D1002F	81349	RESISTOR, FIXED, FILM	EA	9
27	43	PADZZ	5905-197-3172	RN60D2742F	81349	RESISTOR, FIXED, FILM	EA	1
27	44	PADZZ	5905-195-6384	RN60D3012F	81349	RESISTOR, FIXED, FILM	EA	1
27	45	PADZZ	5905-721-2385	RN60D3322F	81349	RESISTOR, FIXED, FILM	EA	1
27	46	PADZZ	5905-147-0269	RN60D1213F	81349	RESISTOR, FIXED, FILM	EA	1
27	47	PADZZ	5905-189-2467	RN60D3011F	81349	RESISTOR, FIXED, FILM	EA	1
27	48	PADZZ	5905-762-1905	RN60D1332F	81349	RESISTOR, FIXED, FILM	EA	1
27	49	PADZZ	5905-707-4872	RN60D3652F	81349	RESISTOR, FIXED, FILM	EA	1
27	50	PADZZ	5905-194-2324	RN60D2213F	81349	RESISTOR, FIXED, FILM	EA	1
27	51	PADZZ	5905-208-3800	RN60D4754F	81349	RESISTOR, FIXED, FILM	EA	1
27	52	PADZZ	5905-147-2062	RN60D2212F	81349	RESISTOR, FIXED, FILM	EA	2
27	53	PADZZ	5905-451-7533	RN60D6811F	81349	RESISTOR, FIXED, FILM	EA	2
27	54	PADZZ	5905-451-7532	RN60D4991F	81349	RESISTOR, FIXED, FILM	EA	1
27	55	PADZZ	5905-984-7681	RN60D2002F	81349	RESISTOR, FIXED, FILM	EA	1
27	56	PADZZ	5905-137-0804	RN60D1003F	81349	RESISTOR, FIXED, FILM	EA	2
27	57	PADZZ	5905-142-0903	RN60D1102F	81349	RESISTOR, FIXED, FILM	EA	2
27	58	PADZZ	5962-148-2858	SN52709L	01295	INTEGRATEL CIRCUIT, OPERATIONAL AMPLIFIER	EA	1
28	1	PADZZ	5910-010-8718	CK06BX103K	81349	GROUP 2A1A8 GENERATOR, WRITE VERTICAL SWEEP	EA	5
28	2	PADZZ	5910-481-1626	CM06FD472J03	81349	CAPACITOR, FIXED, MICA DIELECTRIC	EA	2
28	3	PADZZ	5910-460-0869	CM05FD271J03	81349	CAPACITOR, FIXED, MICA DIELECTRIC	EA	2

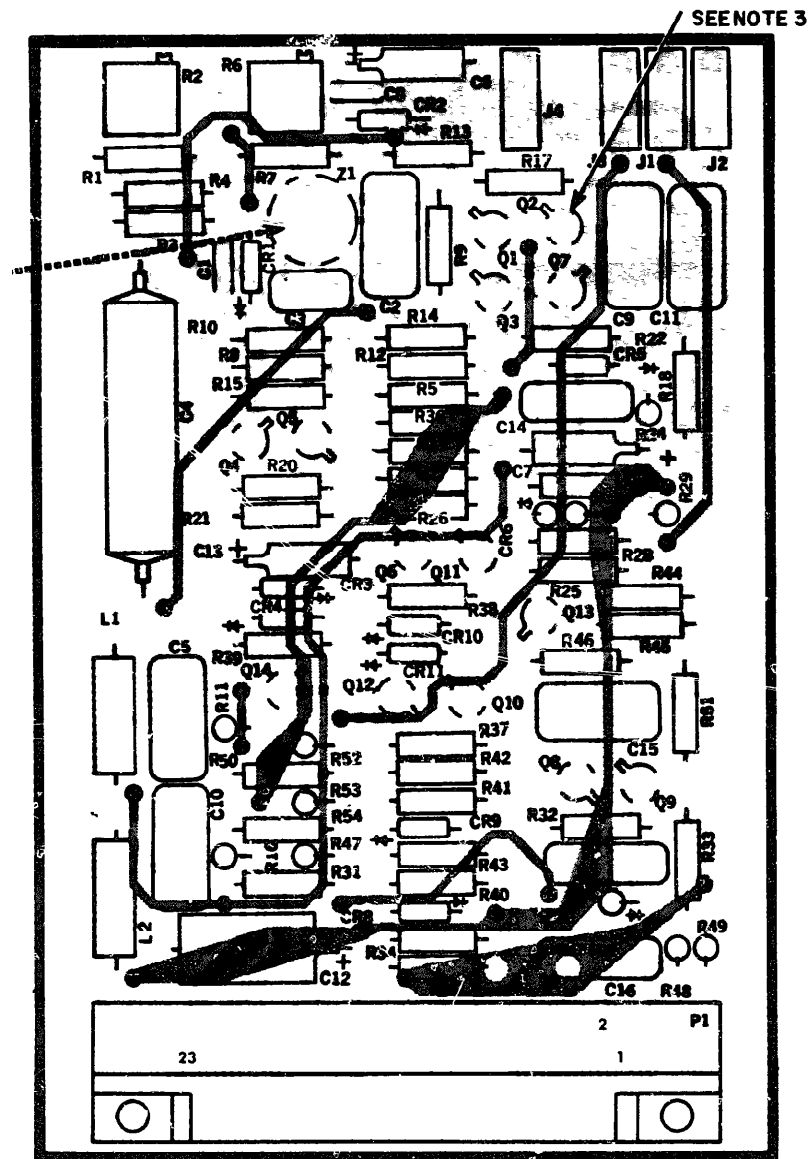

REF DES	ITEM NO	REF DES	ITEM NO	REF DES	ITEM NO
C1	1	E13	15	R17	41
C2	2	E14	15	R18	42
C3	3	E15	16	R19	43
C4	4	J1	17	R20	44
C5	5	J2	18	R21	45
C6	6	J3	19	R22	46
C7	6	J4	20	R23	34
C8	1	L1	21	R24	34
C9	7	L2	21	R25	29
C10	5	P1	22	R26	47
C11	5	Q1	23	R27	48
C12	8	Q2	24	R28	34
C13	6	Q3	23	R29	29
C14	9	Q4	25	R30	49
C15	10	Q5	23	R31	50
C16	5	Q6	25	R32	42
C17	5	Q7	23	R33	42
CR1	11	Q8	23	R34	29
CR2	11	Q9	26	R35	51
CR3	12	Q10	23	R36	52
CR4	13	Q11	23	R37	42
CR5	14	Q12	23	R38	42
CR6	14	Q13	23	R39	52
CR7	14	Q14	23	R40	53
CR8	14	R1	27	R41	42
CR9	14	R2	28	R42	42
CR10	14	R3	29	R43	42
CR11	14	R4	30	R44	54
E1	15	R5	31	R45	53
E2	15	R6	32	R46	55
E3	15	R7	33	R47	42
E4	15	R8	34	R48	56
E5	15	R9	35	R49	57
E6	15	R10	36	R50	30
E7	15	R11	37	R51	29
E8	15	R12	38	R52	29
E9	15	R13	39	R53	56
E10	15	R14	39	R54	57
E11	15	R15	40	Z1	58
E12	15	R16	37		

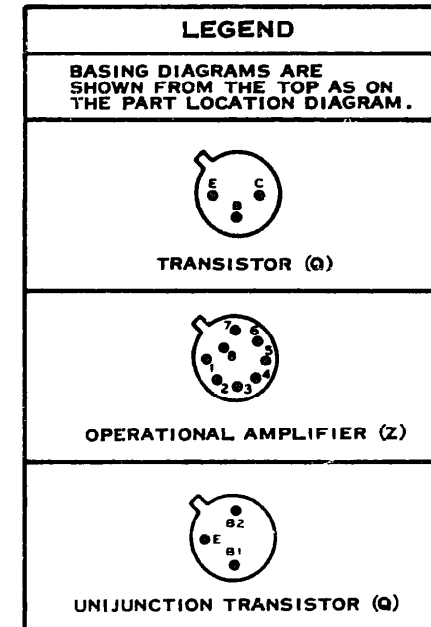

NOTE:

1. LIGHT SHADING INDICATES ETCHED SIDE CIRCUIT PATTERN-DARK SHADING INDICATES COMPONENT SIDE PATTERN.
2. FOR COMPLETE REFERENCE DESIGNATION PREFIX WITH 2A1A7
3. ALL TRANSISTORS (Q1 THROUGH Q14) ARE MOUNTED ON INSULATOR DISKS (E1 THROUGH E14); Z1 IS MOUNTED ON E15

Figure 27 Generator, velocity/height clock pulse

SECTION II REPAIR PARTS LIST (CONTINUED)

(1) ILLUSTRATION		(2) SMR CODE	(3) FEDERAL STOCK NUMBER	(4) PART NUMBER	(5) FSCM	(6) DESCRIPTION	(7) UNIT OF MEAS	(8) QTY INC IN UNIT
(A) FIG NO.	(B) ITEM NO.							
28	4	PADZZ	5910-007-2001	CSR13B566KL	81349	CAPACITOR, FIXED, ELECTROLYTIC	EA	1
28	5	PADZZ	5910-113-5540	CK15BX104K	81349	CAPACITOR, FIXED, CERAMIC DIELECTRIC	EA	1
28	6	PADZZ	5910-136-1037	CSR13G105ML	81349	CAPACITOR, FIXED, ELECTROLYTIC	EA	1
28	7	PADZZ	5961-950-9887	1N827	81349	SEMICONDUCTOR DEVICE, DIODE	EA	1
28	8	PADZZ	5961-846-9157	1N759A	81349	SEMICONDUCTOR DEVICE, DIODE	EA	4
28	9	PADZZ	5961-842-9864	1N914	81349	SEMICONDUCTOR DEVICE, DIODE	EA	12
28	10	PADZZ	5961-054-0339	7717-19DAP	13103	INSULATOR, DISK	EA	2
28	11	PADZZ	5961-734-1105	A10067DAP	07047	INSULATOR, DISK	EA	26
28	12	PADZZ	5935-131-9696	M39024-11-04	81349	JACK, TIP	EA	1
28	13	PADZZ	5935-131-9681	M39024-11-02	81349	JACK, TIP	EA	1
28	14	PADZZ	5935-131-9726	M39024-11-06	81349	JACK, TIP	EA	1
28	15	PADZZ	5935-131-9693	M39024-11-03	81349	JACK, TIP	EA	1
28	16	PADZZ	5950-836-0369	MS90542-15	96906	COIL, RADIO FREQUENCY	EA	1
28	17	PADZZ		UPCCSGM23AACV	97954	CONNECTOR, RECEPTACLE, ELECTRICAL	EA	1
28	18	PADZZ	5961-951-8757	2N2222A	81349	TRANSISTOR	EA	11
28	19	PADZZ	5961-925-3777	2N2907A	81349	TRANSISTOR	EA	10
28	20	PADZZ	5961-252-1577	2N2946A	81349	TRANSISTOR	EA	2
28	21	PADZZ	5961-949-6563	2N2432	81349	TRANSISTOR	EA	3
28	22	PADZZ	5905-988-2313	RN60D1211F	81349	RESISTOR, FIXED, FILM	EA	1
28	23	PADZZ	5905-104-0922	RT24C2P502	81349	RESISTOR, VARIABLE, WIREWOUND	EA	1
28	24	PADZZ	5905-402-0945	RN60E1332F	81349	RESISTOR, FIXED, FILM	EA	1
28	25	PADZZ	5905-448-9360	RN60E1002F	81349	RESISTOR, FIXED, FILM	EA	3
28	26	PADZZ	5905-758-4840	RN60D1501F	81349	RESISTOR, FIXED, FILM	EA	2
28	27	PADZZ	5905-142-0901	RN60D2000F	81349	RESISTOR, FIXED, FILM	EA	3
28	28	PADZZ	5905-988-2310	RN60D1000F	81349	RESISTOR, FIXED, FILM	EA	1
28	29	PADZZ	5905-432-6410	RN60D1001F	81349	RESISTOR, FIXED, FILM	EA	3
28	30	PADZZ	5905-489-2151	RT24C2P103	81349	RESISTOR, VARIABLE, WIREWOUND	EA	1
28	31	PADZZ	5905-189-2454	RN60D1004F	81349	RESISTOR, FIXED, FILM	EA	1
28	32	PADZZ	5905-432-6411	RN60D3320F	81349	RESISTOR, FIXED, FILM	EA	1
28	33	PADZZ	5905-069-3913	RN60D2740F	81349	RESISTOR, FIXED, FILM	EA	1
28	34	PADZZ	5905-192-3479	RN60D9091F	81349	RESISTOR, FIXED, FILM	EA	1
28	35	PADZZ	5905-194-1695	RN60D4751F	81349	RESISTOR, FIXED, FILM	EA	24
28	36	PADZZ	5905-138-1285	RN60D2001F	81349	RESISTOR, FIXED, FILM	EA	1
28	37	PADZZ	5962-148-2858	SN52709L	01295	INTEGRATED CIRCUIT, OPERATIONAL AMPLIFIER	EA	2
28	38	PADZZ	5915-481-3088	811B12	73138	NETWORK, BINARY LADDY	EA	1
28	39	PADZZ	5962-117-6075	SN5473-1	01295	INTEGRATED CIRCUIT, FLIP-FLOP	EA	6
28	40	PADZZ	5962-470-4303	SN5440-1	01295	INTEGRATED CIRCUIT, POWER GATE	EA	1
						GROUP 2A1A9 GENERATOR, ERASE VERTICAL SWEEP		
29	1	PADZZ	5910-010-8718	CK06BX103K	81349	CAPACITOR, FIXED, CERAMIC DIELECTRIC	EA	4
29	2	PADZZ	5910-402-9243	CSR13E396KL	81349	CAPACITOR, FIXED, ELECTROLYTIC	EA	1
29	3	PADZZ	5910-007-2003	CSR13E156KL	81349	CAPACITOR, FIXED, ELECTROLYTIC	EA	1
29	4	PADZZ	5910-481-1626	CM06FD472J03	81349	CAPACITOR, FIXED, MICA DIELECTRIC	EA	1
29	5	PADZZ	5910-460-0869	CM06FD221J03	81349	CAPACITOR, FIXED, MICA DIELECTRIC	EA	1

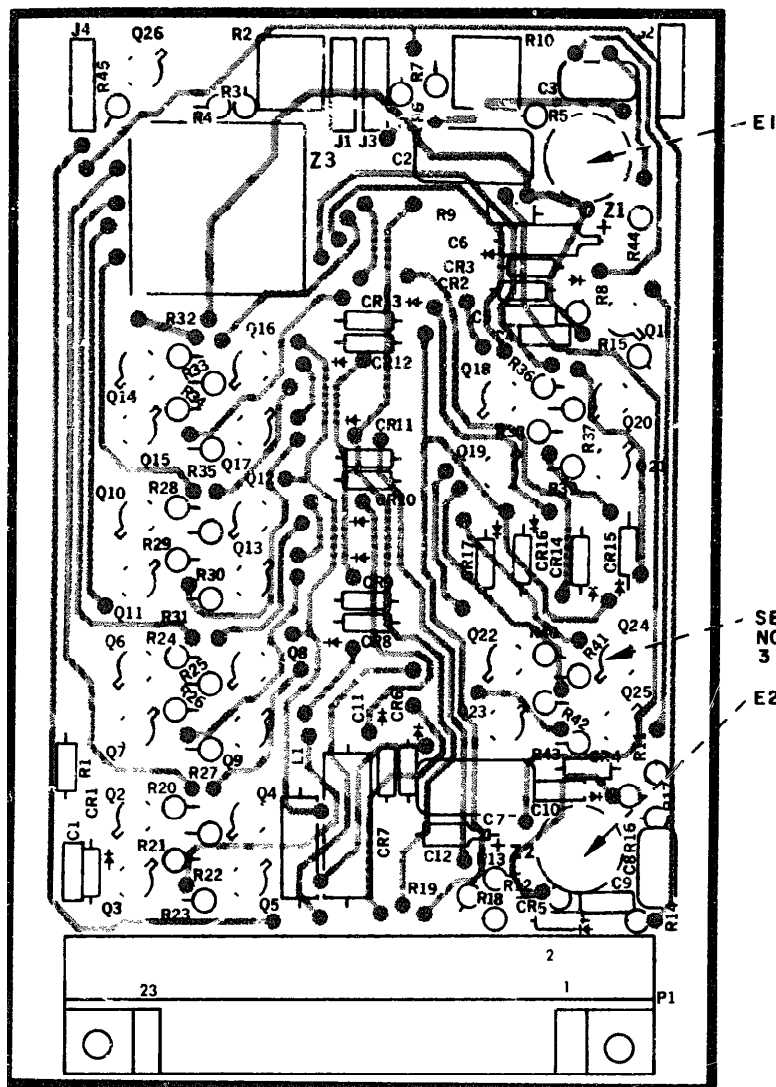

REF DES	ITEM NO	REF DES	ITEM NO	REF DES	ITEM NO	REF DES	ITEM NO
C1	1	E15	11	Q24	20	R41	35
C2	2	E16	11	Q25	21	R42	35
C3	3	E17	11	Q26	21	R43	35
C4	1	E18	11	R1	22	R44	27
C5	1	E19	11	R2	23	R45	36
C6	4	E20	11	R3	24	Z1	37
C7	2	E21	11	R4	25	Z2	37
C8	3	E22	11	R5	26	Z3	38
C9	1	E23	11	R6	27	Z4	39
C10	1	E24	11	R7	27	Z5	39
C11	5	E25	11	R8	28	Z6	39
C12	6	E26	11	R9	29	Z7	39
CR1	7	E27	11	R10	30	Z8	39
CR2	8	E28	11	R11	31	Z9	39
CR3	8	J1	12	R12	25	Z10	40
CR4	8	J2	13	R13	26		
CR5	8	J3	14	R14	32		
CR6	9	J4	15	R15	33		
CR7	9	L1	16	R16	29		
CR8	9	P1	17	R17	25		
CR9	9	Q1	18	R18	34		
CR10	9	Q2	19	R19	29		
CR11	9	Q3	18	R20	35		
CR12	9	Q4	19	R21	35		
CR13	9	Q5	18	R22	35		
CR14	9	Q6	19	R23	35		
CR15	9	Q7	18	R24	35		
CR16	9	Q8	19	R25	35		
CR17	9	Q9	18	R26	35		
E1	10	Q10	19	R27	35		
E2	10	Q11	18	R28	35		
E3	11	Q12	19	R29	35		
E4	11	Q13	18	R30	35		
E5	11	Q14	19	R31	35		
E6	11	Q15	18	R32	35		
E7	11	Q16	19	R33	35		
E8	11	Q17	18	R34	35		
E9	11	Q18	19	R35	35		
E10	11	Q19	18	R36	35		
E11	11	Q20	19	R37	35		
E12	11	Q21	18	R38	35		
E13	11	Q22	20	R39	35		
E14	11	Q23	21	R40	35		

LEGEND

BASING DIAGRAMS ARE SHOWN FROM THE TOP AS ON THE PART LOCATION DIAGRAM.

TRANSISTOR (Q)

OPERATIONAL AMPLIFIER (Z)

NOTE:

1. LIGHT SHADING INDICATES ETCHED SIDE CIRCUIT PATTERN—DARK SHADING INDICATES COMPONENT SIDE PATTERN.
2. FOR COMPLETE REFERENCE DESIGNATION PREFIX WITH 2A1A8.
3. EACH TRANSISTOR (Q1 THROUGH Q26) IS MOUNTED ON AN INSULATOR DISC (E3 THROUGH E28), Z1 AND Z2 ARE MOUNTED ON E1 AND E2, RESPECTIVELY

Figure 28. Generator, write vertical sweep

SECTION II REPAIR PARTS LIST (CONTINUED)

(1) ILLUSTRATION		(2) SMR CODE	(3) FEDERAL STOCK NUMBER	(4) PART NUMBER	(5) FSCM	(6) DESCRIPTION	(7) UNIT OF MEAS	(8) QTY INC IN UNIT
(A) FIG NO.	(B) ITEM NO.							
29	6	PADZZ	5910-236-8740	CSR13C475KL	81349	CAPACITOR, FIXED, ELECTROLYTIC	EA	1
29	7	PADZZ	5910-050-2940	LP9A1A105J	01884	CAPACITOR, FIXED, PLASTIC DIELECTRIC	EA	1
29	8	PADZZ	5961-842-9864	1N914	81349	SEMICONDUCTOR DEVICE, DIODE	EA	5
29	9	PADZZ	5961-821-2309	1N751A	81349	SEMICONDUCTOR DEVICE, DIODE	EA	1
29	10	PADZZ	5961-995-2310	1N752A	81349	SEMICONDUCTOR DEVICE, DIODE	EA	1
29	11	PADZZ	5961-752-6121	1N753A	81349	SEMICONDUCTOR DEVICE, DIODE	EA	3
29	12	PADZZ	5961-846-9157	1N759A	81349	SEMICONDUCTOR DEVICE, DIODE	EA	1
29	13	PADZZ	5961-919-4224	7717-44N	13103	INSULATOR, DISK	EA	16
29	14	PADZZ	5961-054-0339	7717-19DAP	13103	INSULATOR, DISK	EA	2
29	15	PADZZ	5935-131-9696	M39024-11-04	81349	JACK, TIP	EA	1
29	16	PADZZ	5935-131-9681	M39024-11-02	81349	JACK, TIP	EA	1
29	17	PADZZ	5935-131-9726	M39024-11-06	81349	JACK, TIP	EA	1
29	18	PADZZ	5935-131-9728	M39024-11-08	81349	JACK, TIP	EA	1
29	19	PADZZ	5935-141-9697	M39024-11-05	81349	JACK, TIP	EA	1
29	20	PADZZ	5935-131-9693	M39024-11-03	81349	JACK, TIP	EA	1
29	21	PADZZ	5950-771-2089	MS75054-5	96906	COIL, RADIO FREQUENCY	EA	1
29	22	PADZZ	5935-236-7729	UPCC30M3AACU	97934	CONNECTOR, RECEPTACLE, ELECTRICAL	EA	1
29	23	PADZZ	5961-951-8757	2N2222A	81349	TRANSISTOR	EA	4
29	24	PADZZ	5961-949-6563	2N2432	81349	TRANSISTOR	EA	4
29	25	PADZZ	5961-226-8579	2N930	81349	TRANSISTOR	EA	4
29	26	PADZZ	5961-431-3246	2N3821	81349	TRANSISTOR	EA	2
29	27	PADZZ	5961-925-2777	2N3907A	81349	TRANSISTOR	EA	2
29	28	PADZZ	5905-957-8633	RN60D5191F	81349	RESISTOR, FIXED, FILM	EA	1
29	29	PADZZ	5905-983-6914	RN60D1302F	81349	RESISTOR, FIXED, FILM	EA	6
29	30	PADZZ	5905-194-1695	RN60D4751F	81349	RESISTOR, FIXED, FILM	EA	1
29	31	PADZZ	5905-998-9178	RT402P202	81349	RESISTOR, VARIABLE, WIREWOUND	EA	1
29	32	PADZZ	5906-969-5846	RN60D3921F	81349	RESISTOR, FIXED, FILM	EA	3
29	33	PADZZ	5905-758-4840	RN60D1501F	81349	RESISTOR, FIXED, FILM	EA	2
29	34	PADZZ	5905-984-7681	RN60D2902F	81349	RESISTOR, FIXED, FILM	EA	4
29	35	PADZZ	5905-142-0901	RN60D2000F	81349	RESISTOR, FIXED, FILM	EA	1
29	36	PADZZ	5905-025-5987	RN60D2491F	81349	RESISTOR, FIXED, FILM	EA	1
29	37	PADZZ	5905-432-6410	RN60D1301F	81349	RESISTOR, FIXED, FILM	EA	5
29	38	PADZZ	5905-758-2063	RN60D2210F	81349	RESISTOR, FIXED, FILM	EA	1
29	39	PADZZ	5905-721-2387	RN60D6190F	81349	RESISTOR, FIXED, FILM	EA	1
29	40	PADZZ	5905-404-8782	RN60D2437F	81349	RESISTOR, FIXED, FILM	EA	1
29	41	PADZZ	5905-211-0230	RN60D2411F	81349	RESISTOR, FIXED, FILM	EA	2
29	42	PADZZ	5905-439-2154	RT40P103	81349	RESISTOR, VARIABLE, WIREWOUND	EA	1
29	43	PADZZ	5905-066-6382	RN60D1001F	81349	RESISTOR, FIXED, FILM	EA	1
29	44	PADZZ	5905-052-1700	RN60D1027F	81349	RESISTOR, FIXED, FILM	EA	1
29	45	PADZZ	5905-032-1700	RN60D1027F	81349	RESISTOR, FIXED, FILM	EA	4
29	46	PADZZ	5905-032-1700	RN60D1027F	81349	RESISTOR, FIXED, FILM	EA	1
29	47	PADZZ	5905-032-1700	RN60D1027F	81349	RESISTOR, FIXED, FILM	EA	1
29	48	PADZZ	5905-032-1700	RN60D1027F	81349	RESISTOR, FIXED, FILM	EA	1
29	49	PADZZ	5905-032-1700	RN60D1027F	81349	RESISTOR, FIXED, FILM	EA	1
29	50	PADZZ	5905-032-1700	RN60D1027F	81349	RESISTOR, FIXED, FILM	EA	1

SECTION II REPAIR PARTS LIST (CONTINUED)

(1) ILLUSTRATION		(2) SMR CODE	(3) FEDERAL STOCK NUMBER	(4) PART NUMBER	(5) FSCM	(6) DESCRIPTION	(7) UNST OF MEAS	(8) QTY INC IN UNST
(A) FIG NO.	(B) ITEM NO							
29	49	PADZZ	5905-243-5622	RN60D3017F	81349	RESISTOR, FIXED, FILM	EA	1
29	50	PADZZ	5905-232-7791	RN60D1500F	81349	RESISTOR, FIXED, FILM	EA	1
29	51	PADZZ	5905-195-6404	RN60D3922F	81349	RESISTOR, FIXED, FILM	EA	1
29	52	PADZZ	5905-195-6377	RN60D1502F	81349	RESISTOR, FIXED, FILM	EA	2
29	53	PADZZ	5905-229-7824	53007-11	96214	RESISTOR, FIXED, FILM	EA	1
29	54	PADZZ	5905-195-6379	RN60D1822F	81349	RESISTOR, FIXED, FILM	EA	2
29	55	PADZZ	5905-452-0773	RN60D8252F	81349	RESISTOR, FIXED, FILM	EA	1
29	56	PADZZ	5905-175-8541	RN60C4220F	81349	RESISTOR, FIXED, FILM	EA	1
29	57	PADZZ	5905-432-9159	RN60C787.F	81349	RESISTOR, FIXED, FILM	EA	1
29	58	PADZZ	5962-248-2336	SN52710I	01295	INTEGRATED CIRCUIT, DIFFERENTIATING COMPARTOP	EA	1
29	59	PADZZ	5962-148-2858	SN52709L	01295	INTEGRATED CIRCUIT, OPERATIONAL AMPLIFIER	EA	1
GROUP 2A1A10 LOGIC, AUXILIARY DEFLECTION								
30	1	PADZZ	5910-010-8718	CK06BX103K	81349	CAPACITOR, FIXED, CERAMIC DIELECTRIC	EA	5
30	2	PADZZ	5910-229-7786	CU13CH470SP	81349	CAPACITOR, FIXED, ELECTROLYTIC	EA	2
30	3	PADZZ	5910-832-8080	CM05CD180J03	81349	CAPACITOR, FIXED, MICA DIELECTRIC	EA	2
30	4	PADZZ	5910-725-4794	CM06FD22J03	81349	CAPACITOR, FIXED, MICA DIELECTRIC	EA	2
30	5	PADZZ	5910-490-0397	CM05CD470J03	81349	CAPACITOR, FIXED, MICA DIELECTRIC	EA	1
30	6	PADZZ	5910-410-9329	CM06FD102J03	81349	CAPACITOR, FIXED, MICA DIELECTRIC	EA	1
30	7	PADZZ	5910-456-9511	CM06FD272J03	81349	CAPACITOR, FIXED, MICA DIELECTRIC	EA	1
30	8	PADZZ	5961-836-0382	1N3022B	81349	SEMICONDUCTOR DEVICE, DIODE	EA	1
30	9	PADZZ	5961-752-6121	1N753A	1349	SEMICONDUCTOR DEVICE, DIODE	EA	1
30	10	PADZZ	5961-842-9864	1N914	81349	SEMICONDUCTOR DEVICE, DIODE	EA	1
30	11	PADZZ	5961-879-3091	1N755A	81349	SEMICONDUCTOR DEVICE, DIODE	EA	1
30	12	PADZZ	5999-484-5513	7717-18N	13103	INSULATOR, DISK	EA	5
30	13	PADZZ	5961-909-4138	10162DAP	07047	INSULATOR, DISK	EA	1
30	14	PADZZ	5961-054-0339	7717-19DAP	13103	INSULATOR, DISK	EA	1
30	15	PADZZ	5935-131-9696	M39024-11-04	81349	JACK, TIP	EA	1
30	16	PADZZ	5935-131-9681	M39024-11-02	81349	JACK, TIP	EA	1
30	17	PADZZ	5935-131-9726	M39024-11-06	81349	JACK, TIP	EA	1
30	18	PADZZ	5935-131-9693	M39024-11-03	81349	JACK, TIP	EA	1
30	19	PADZZ	5950-233-6853	MS90542-6	96906	COIL, RADIO FREQUENCY	EA	1
30	20	PADZZ	5935-243-8517	UPCCSGM23AADJ	97994	CONNECTOR, RECEPTACLE, ELECTRICAL	EA	1
30	21	PADZZ	5961-951-8757	2N2222A	81349	TRANSISTOR	EA	3
30	22	PADZZ	5961-226-8579	2N93C	81349	TRANSISTOR	EA	2
30	23	PADZZ	5961-949-1432	2N2219	81349	TRANSISTOR	EA	1
30	24	PADZZ	5905-232-7808	RN60D82R5F	81349	RESISTOR, FIXED, FILM	EA	1
30	25	PADZZ	5905-857-6107	RN65D2000F	81349	RESISTOR, FIXED, FILM	EA	1
30	26	PADZZ	5905-192-3479	RN60D9091F	81349	RESISTOR, FIXED, FILM	EA	2
30	27	PADZZ	5905-988-2310	RN60D1000F	81349	RESISTOR, FIXED, FILM	EA	2
30	28	PADZZ	5905-255-3664	RT22C2P103	81349	RESISTOR, VARIABLE, WIREWOUND	EA	4
30	29	PADZZ	5905-6914	RN60D1002F	81349	RESISTOR, FIXED, FILM	EA	4
30	30	PADZZ	5905-261-7693	RN60D1621F	81349	RESISTOR, FIXED, FILM	EA	1
30	31	PADZZ	5905-424-9312	RT22C2P201	81349	RESISTOR, VARIABLE, WIREWOUND	EA	1

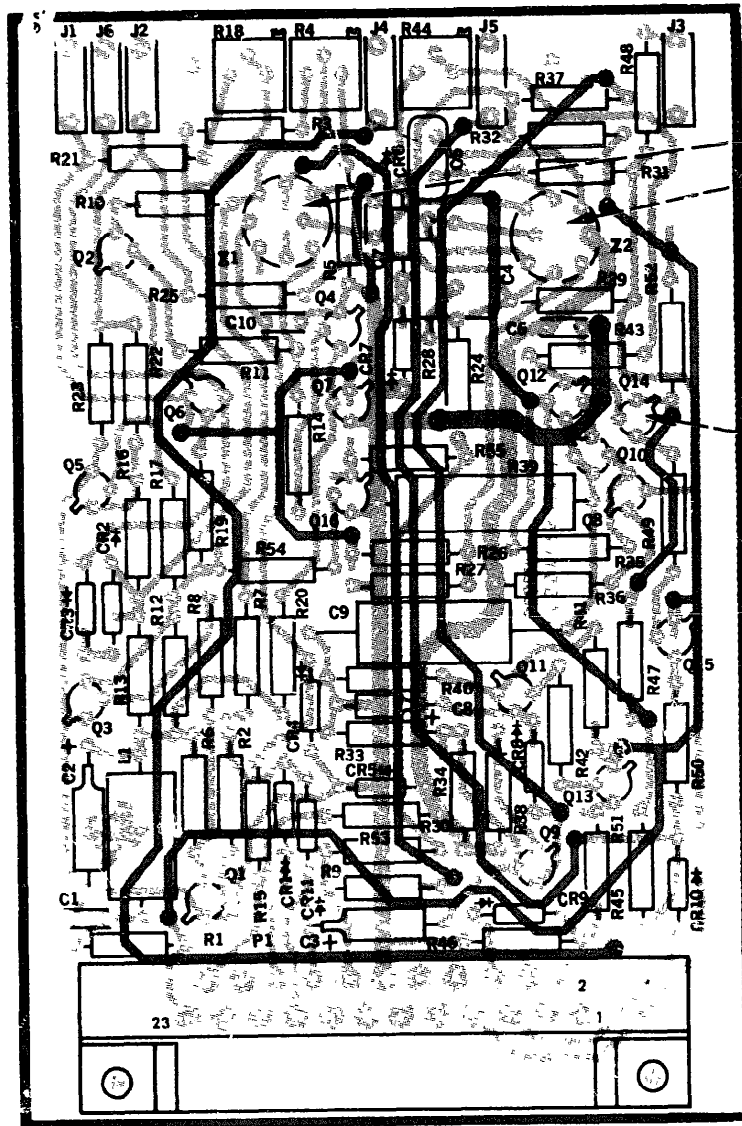

REF DES	ITEM NO	REF DES	ITEM NO	REF DES	ITEM NO
C1	1	J2	16	R18	42
C2	2	J3	17	R19	41
C3	3	J4	18	R20	29
C4	4	J5	19	R21	43
C5	5	J6	20	R22	44
C6	1	L1	21	R23	45
C7	1	PI	22	R24	46
C8	6	Q1	23	R25	34
C9	7	Q2	23	R26	43
C10	1	Q3	23	R27	47
CR1	8	Q4	23	R28	33
CR2	9	Q5	24	R29	48
CR3	10	Q6	24	R30	49
CR4	11	Q7	24	R31	37
CR5	12	Q8	25	R32	50
CR6	11	Q9	25	R33	51
CR7	11	Q10	26	R34	52
CR8	8	Q11	25	R35	29
CR9	8	Q12	26	R36	29
CR10	8	Q13	27	R37	34
CR11	8	Q14	25	R38	47
E1	13	Q15	27	R39	53
E2	13	Q16	24	R40	32
E3	13	R1	28	R41	54
E4	13	R2	29	R42	55
E5	13	R3	30	R43	45
E6	13	R4	31	R44	42
E7	13	R5	32	R45	45
E8	13	R6	33	R46	37
E9	13	R7	34	R47	32
E10	13	R8	34	R48	37
E11	13	R9	35	R49	55
E12	13	R10	36	R50	45
E13	13	R11	29	R51	37
E14	13	R12	37	R52	54
E15	13	R13	38	R53	56
E16	13	R14	29	R54	52
E17	14	R15	39	R55	57
E18	14	R16	40	Z1	58
J1	15	R17	41	Z2	59

SEE NOTE 3

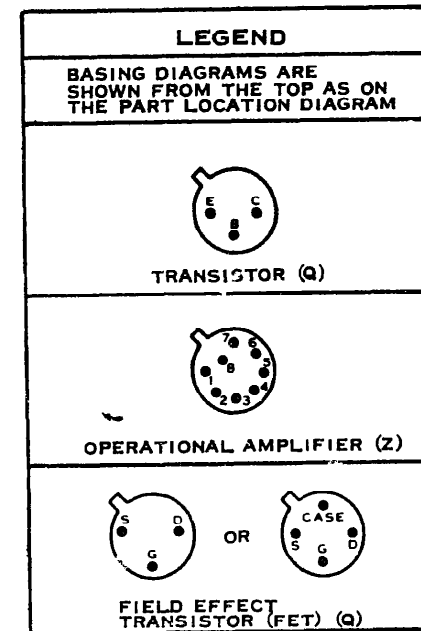

NOTE:

1. LIGHT SHADING INDICATES ETCHED SIDE CIRCUIT PATTERN—DARK SHADING INDICATES COMPONENT SIDE PATTERN.
2. FOR COMPLETE REFERENCE DESIGNATION PREFIX WITH 2A1A9
3. TRANSISTORS (Q1 THROUGH Q16) ARE MOUNTED ON INSULATOR DISCS (E1 THROUGH E16)

EL 6625-1824-40P-TM-29

Figure 29. Generator, erase vertical sweep

SECTION II REPAIR PARTS LIST (CONTINUED)

(1) ILLUSTRATION		(2) SMR CODE	(3) FEDERAL STOCK NUMBER	(4) PART NUMBER	(5) FSCM	(6) DESCRIPTION	USABLE ON CODE	(7) UNIT OF MEAS	(8) QTY INC IN UNIT
(A) FIG NO.	(B) ITEM NO.								
30	32	PADZZ	5905-099-0545	RN60D1820F	81349	RESISTOR, FIXED, FILM		EA	1
30	33	PADZZ	5905-189-2474	RN60D4790F	81349	RESISTOR, FIXED, FILM		EA	2
30	34	PADZZ	5905-138-1285	RN60D2001F	81349	RESISTOR, FIXED, FILM		EA	2
30	35	PADZZ	5905-006-6988	RN60D7501F	81349	RESISTOR, FIXED, FILM		EA	1
30	36	PADZZ	5905-432-6410	RN60D1001F	81349	RESISTOR, FIXED, FILM		EA	7
30	37	PADZZ	5905-951-5717	RN60D3651F	81349	RESISTOR, FIXED, FILM		EA	1
30	38	PADZZ	5905-581-1007	RN75B5620F	81349	RESISTOR, FIXED, FILM		EA	1
30	39	PADZZ	5905-142-0901	RN60D2000F	81349	RESISTOR, FIXED, FILM		EA	1
30	40	PADZZ	5905-036-8778	RN60D5110F	81349	RESISTOR, FIXED, FILM		EA	1
30	41	PADZZ	5905-025-5987	RN60D7491F	81349	RESISTOR, FIXED, FILM		EA	1
30	42	PADZZ	5905-764-1182	RT2202P200	81349	RESISTOR, VARIABLE, WIRFWOUND		EA	1
30	43	PADZZ	5905-069-3917	RN60D3651F	81349	RESISTOR, FIXED, FILM		EA	1
30	44	PADZZ	5905-195-6379	RN60D1822F	81349	RESISTOR, FIXED, FILM		EA	1
30	45	PADZZ	5905-721-2385	RN60D3322F	81349	RESISTOR, FIXED, FILM		EA	1
30	46	PADZZ	5905-025-5988	RN60D3321F	81349	RESISTOR, FIXED, FILM		EA	1
30	47	PADZZ	5905-452-0773	RN60D8252F	81349	RESISTOR, FIXED, FILM		EA	1
30	48	PADZZ	5905-192-3876	RN60D1503F	81349	RESISTOR, FIXED, FILM		EA	1
30	49	PADZZ	5905-189-2479	RN60D5622F	81349	RESISTOR, FIXED, FILM		EA	1
30	50	PADZZ	5905-147-2062	RN60D2712F	81349	RESISTOR, FIXED, FILM		EA	1
30	51	PADZZ	5905-767-0984	RN60D4321F	81349	RESISTOR, FIXED, FILM		EA	1
30	52	PADZZ	5905-073-8293	RN60D1821F	81349	RESISTOR, FIXED, FILM		EA	1
30	53	PADZZ	5905-112-7056	RN60D5620F	81349	RESISTOR, FIXED, FILM		EA	1
30	54	PADZZ	5962-245-5325	SN52700	01295	INTEGRATED CIRCUIT, OPERATIONAL AMPLIFIER		EA	2
30	55	PADZZ	5962-248-2336	SN52710L	01295	INTEGRATED CIRCUIT, DIFFERENTIATING COMPARTOR		EA	1
GROUP 2A1A11 GENERATOR PARTS									
31	1	PADZZ	5910-229-7786	CU1304705F3	81349	CAPACITOR, FIXED, ELECTROLYTIC		EA	2
31	2	PADZZ	5910-010-8718	CK06BY103F	81349	CAPACITOR, FIXED, CERAMIC DIELECTRIC		EA	12
31	3	PADZZ	5910-481-1626	CM06F0475003	81349	CAPACITOR, FIXED, MICA DIELECTRIC		EA	1
31	4	PADZZ	5910-456-0800	CM05F0201J03	81349	CAPACITOR, FIXED, MICA DIELECTRIC		EA	1
31	5	PADZZ	5910-954-5496	CM05ED200J03	81349	CAPACITOR, FIXED, MICA		EA	1
31	6	PADZZ	5910-113-5540	CK15BX104K	81349	CAPACITOR, FIXED, CERAMIC DIELECTRIC		EA	1
31	7	PADZZ	5961-836-0382	JN3022B	81349	SEMICONDUCTOR DEVICE, DIODE		EA	1
31	8	PADZZ	5961-752-6121	1N753A	81349	SEMICONDUCTOR DEVICE, DIODE		EA	1
31	9	PADZZ	5961-842-9864	1N914	81349	SEMICONDUCTOR DEVICE, DIODE		EA	2
31	10	PADZZ	5961-734-1105	A10067DAP	07047	INSULATOR, DISK		EA	4
31	11	PADZZ	5961-254-0339	7717-1904P	13103	INSULATOR, DISK		EA	2
31	12	PADZZ	5935-131-9696	M39024-11-02	81349	TACK		EA	1
31	13	PADZZ	5935-131-9681	M39024-11-0	81349	TACK, TIP		EA	1
31	14	PADZZ	5935-131-9693	M39024-11-03	81349	TACK, TIP		EA	1
31	15	PADZZ	5950-892-8329	42740534	06006	COIL, RADIO FREQUENCY		EA	2
31	16	PADZZ	5935-236-7729	UP0090M-AA	70007	CONNECTOR, RECEPTACLE, ELECTRICAL		EA	1
31	17	PADZZ	5961-949-6563	2N2130	81349	TRANSISTOR		EA	2
31	18	PADZZ	5961-226-8579						

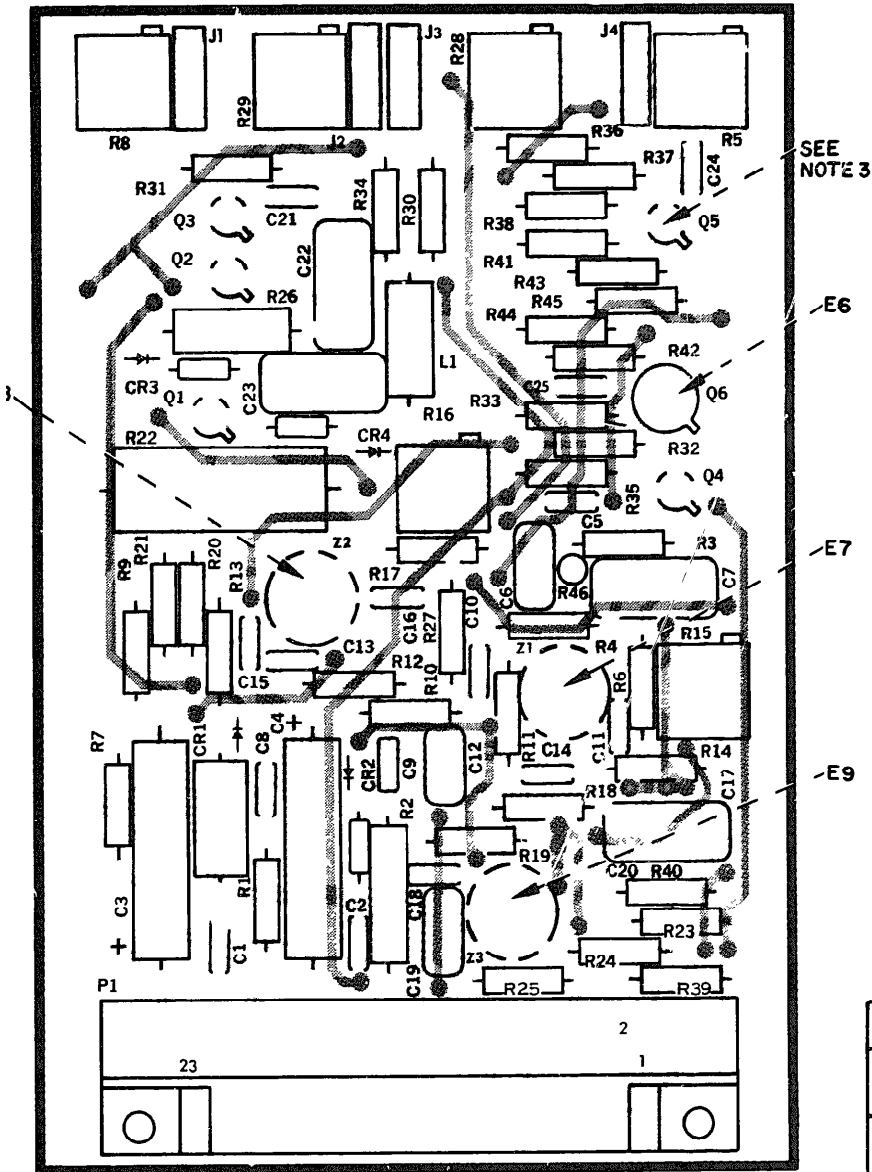

REF DES.	ITEM NO	REF DES	ITEM NO	REF DES	ITEM NO.
C1	1	E5	12	R17	29
C2	1	E6	13	R18	27
C3	2	E7	14	R19	37
C4	2	E8	14	R20	36
C5	1	E9	14	R21	36
C6	3	J1	15	R22	38
C7	4	J2	16	R23	29
C8	1	J3	17	R24	39
C9	1	J4	18	R25	34
C10	1	L1	19	R26	40
C11	1	P1	20	R27	41
C12	5	Q1	21	R28	28
C13	1	Q2	22	R29	42
C14	1	Q3	21	R30	43
C15	1	Q4	21	R31	36
C16	1	Q5	22	R32	44
C17	4	Q6	23	R33	45
C18	1	R1	24	R34	46
C19	5	R2	25	R35	36
C20	1	R3	26	R36	47
C21	3	R4	27	R37	48
C22	6	R5	28	R38	49
C23	7	R6	29	R39	26
C24	1	R7	30	R40	36
C25	1	R8	31	R41	50
CR1	8	R9	32	R42	51
CR2	9	R10	33	R43	52
CR3	10	R11	34	R44	53
CR4	11	R12	33	R45	36
E1	12	R13	35	R46	29
E2	12	R14	36	Z1	54
E3	12	R15	28	Z2	55
E4	12	R16	28	Z3	54

LEGEND

BASING DIAGRAMS ARE SHOWN FROM THE TOP AS ON THE PART LOCATION DIAGRAM

TRANSISTOR (Q)

OPERATIONAL AMPLIFIER (Z)

- NOTE:**
- 1 LIGHT SHADING INDICATES ETCHED SIDE CIRCUIT PATTERN—DARK SHADING INDICATES COMPONENT SIDE PATTERN.
 2. FOR COMPLETE REFERENCE DESIGNATION PREFIX WITH 2A1A10
 3. TRANSISTORS(Q1 THROUGH Q5)ARE MOUNTED ON INSULATOR DISKS(E1 THROUGH E5);Q6,Z1, Z2,AND Z3 ARE MOUNTED ON E6 THROUGH E9 AS INDICATED

Figure 30. Logic, auxiliary deflection

SECTION II REPAIR PARTS LIST (CONTINUED)

(1) ILLUSTRATION		(2) SMR CODE	(3) FEDERAL STOCK NUMBER	(4) PART NUMBER	(5) FSCM	(6) DESCRIPTION	(7) UNIT OF MEAS	(8) QTY INC IN UNIT
(A) FIG NO.	(B) ITEM NO.							
31	19	PADZZ	5961-949-1432	2N2219A	81349	TRANSISTOR	EA	1
31	20	PADZZ	5905-232-7808	RN60D82R5F	81349	RESISTOR, FIXED, FILM	EA	1
31	21	PADZZ	5905-176-2398	RN65D43P0F	81349	RESISTOR, FIXED, FILM	EA	1
31	22	PADZZ	5905-142-0901	RN60D2000F	81349	RESISTOR, FIXED, FILM	EA	3
31	23	PADZZ	5905-255-3664	RT22C2P103	81349	RESISTOR, VARIABLE, WIREWOUND	EA	1
31	24	PADZZ	5905-452-0768	RN60D6191F	81349	RESISTOR, FIXED, FILM	EA	1
31	25	PADZZ	5905-432-6410	RN60D1001F	81349	RESISTOR, FIXED, FILM	EA	3
31	26	PADZZ	5905-951-5717	RN60D3651F	81349	RESISTOR, FIXED, FILM	EA	1
31	27	PADZZ	5905-758-4840	RN60D1501F	81349	RESISTOR, FIXED, FILM	EA	2
31	28	PADZZ	5905-983-6914	RN60D1002F	81349	RESISTOR, FIXED, FILM	EA	2
31	29	PADZZ	5905-767-0978	RN60D2490F	81349	RESISTOR, FIXED, FILM	EA	1
31	30	PADZZ	5905-707-4872	RN60D3652F	81349	RESISTOR, FIXED, FILM	EA	1
31	31	PADZZ	5905-195-6404	RN60D3922F	81349	RESISTOR, FIXED, FILM	EA	1
31	32	PADZZ	5905-208-3800	RN60D4752F	81349	RESISTOR, FIXED, FILM	EA	1
31	33	PADZZ	5905-189-2474	RN60D4750F	81349	RESISTOR, FIXED, FILM	EA	1
31	34	PADZZ	5905-957-8633	RN60D51R1F	81349	RESISTOR, FIXED, FILM	EA	1
31	35	PADZZ	5905-452-0742	RN60D1100F	81349	RESISTOR, FIXED, FILM	EA	1
31	36	PADZZ	5905-138-1285	RN60D2001F	81349	RESISTOR, FIXED, FILM	EA	1
31	37	PADZZ	5962-248-2336	SN52710L	01295	INTEGRATED CIRCUIT, DIFFERENTIATING COMPARATOR	EA	1
31	38	PADZZ	5962-148-2858	SN52709L	01295	INTEGRATED CIRCUIT, OPERATIONAL AMPLIFIER GROUP 2A1A12 SWEEP AND BLANKING, GENERATOR CS-VC	EA	1
32	1	PADZZ	5910-088-1146	CM05FD331J03	81349	CAPACITOR, FIXED, MICA DIELECTRIC	EA	2
32	2	PADZZ	5910-410-9329	CM06FD102J03	81349	CAPACITOR, FIXED, MICA DIELECTRIC	EA	2
32	3	PADZZ	5910-010-8718	CK06BX103K	81349	CAPACITOR, FIXED, CERAMIC DIELECTRIC	EA	2
32	4	PADZZ	5910-113-5499	CK06BX104K	81349	CAPACITOR, FIXED, CERAMIC DIELECTRIC	EA	2
32	5	PADZZ	5910-144-4383	CSR13F226KL	81349	CAPACITOR, FIXED, ELECTROLYTIC	EA	2
32	6	PADZZ	5910-450-5239	LP9A1A104J	01884	CAPACITOR, FIXED, PLASTIC DIELECTRIC	EA	1
32	7	PADZZ	5910-460-1047	CMC5ED510J03	81349	CAPACITOR, FIXED, MICA DIELECTRIC	EA	1
32	8	PADZZ	5910-060-1190	CM06FD681J03	81349	CAPACITOR, FIXED, MICA DIELECTRIC	EA	1
32	9	PADZZ	5910-460-0869	CM05FD223J03	81349	CAPACITOR, FIXED, MICA DIELECTRIC	EA	2
32	10	PADZZ	5910-113-9453	CK06BX105K	81349	CAPACITOR, FIXED, CERAMIC DIELECTRIC	EA	2
32	11	PADZZ	5910-481-1005	LP9A1A473J	01884	CAPACITOR, FIXED, PLASTIC DIELECTRIC	EA	1
32	12	PADZZ	5910-442-5005	LP9A1E224J	01884	CAPACITOR, FIXED, PLASTIC DIELECTRIC	EA	1
32	13	PADZZ	5961-842-9864	1N914	81349	SEMICONDUCTOR DEVICE, DIODE	EA	11
32	14	PADZZ	5961-087-6047	1N645	81349	SEMICONDUCTOR DEVICE, DIODE	EA	2
32	15	PADZZ	5961-752-6121	1N753A	81349	SEMICONDUCTOR DEVICE, DIODE	EA	2
32	16	PADZZ	5961-919-4224	7717-44N	13100	INSULATOR, DISK	EA	13
32	17	PADZZ	5935-131-9697	M39024-11-05	81349	JACK, TIP	EA	1
32	18	PADZZ	5935-131-9727	M39024-11-07	81349	JACK, TIP	EA	1
32	19	PADZZ	5935-131-9696	M39024-11-04	81349	JACK, TIP	EA	1
32	20	PADZZ	5950-727-2680	MS75052-5	96906	COIL, RADIO FREQUENCY	EA	2
32	21	PADZZ	5935-242-2068	UPCCSGM23AADR	97954	CONNECTOR, RECEPTACLE, ELECTRICAL	EA	1
32	22	PADZZ	5961-951-8757	2N2222A	81349	TRANSISTOR	EA	9

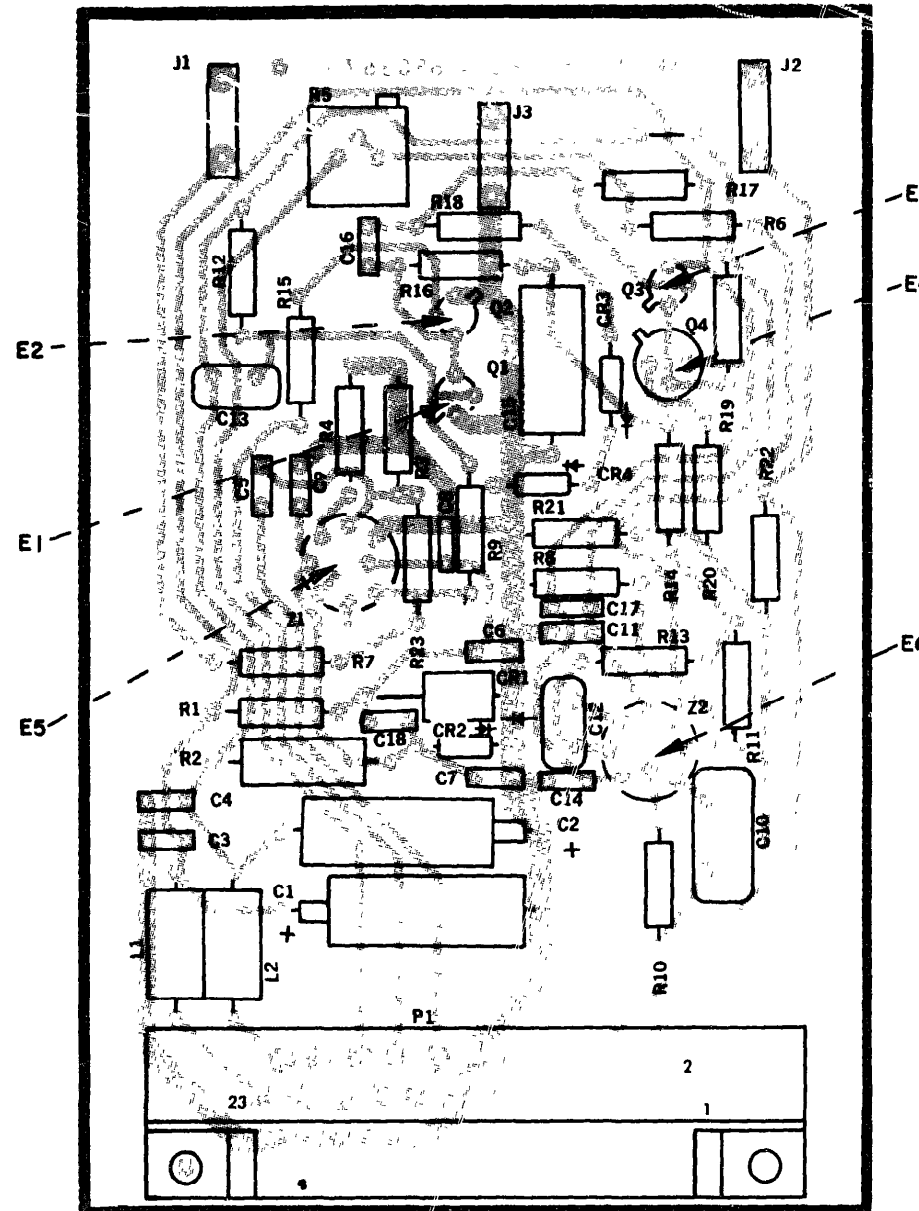

REF. DES.	ITEM NO.	REF. DES.	ITEM NO.	REF. DES.	ITEM NO.	REF. DES.	ITEM NO.
C1	1	C17	2	L2	15	R11	28
C2	1	C18	2	P1	16	R12	28
C3	2	CR1	7	Q1	17	R13	22
C4	2	CR2	8	Q2	17	R14	29
C5	2	CR3	9	Q3	18	R15	25
C6	2	CR4	9	Q4	19	R16	27
C7	2	E1	10	R1	20	R17	30
C8	2	E2	10	R2	21	R18	31
C9	2	E3	10	R3	22	R19	32
C10	3	E4	10	R4	22	R20	33
C11	2	E5	11	R5	23	R21	34
C12	4	E6	11	R6	24	R22	35
C13	5	J1	12	R7	25	R23	36
C14	2	J2	13	R8	26	Z1	37
C15	6	J3	14	R9	25	Z2	38
C16	2	L1	15	R10	27		

LEGEND

BASING DIAGRAMS ARE SHOWN FROM THE TOP AS ON THE PART LOCATION DIAGRAM.

TRANSISTOR (Q)

OPERATIONAL AMPLIFIER (Z)

NOTE:

1. LIGHT SHADING INDICATES ETCHED SIDE CIRCUIT PATTERN-DARK SHADING INDICATES COMPONENT SIDE PATTERN.
2. FOR COMPLETE REFERENCE DESIGNATION PREFIX WITH 2A1A11.
3. E1 THROUGH E6 ARE INSULATOR DISKS MOUNTED UNDER COMPONENTS AS INDICATED.

EL6625-1824-40P-TM-31

Figure 31. Generator, dither

SECTION II REPAIR PARTS LIST (CONTINUED)

(1) ILLUSTRATION		(2) SMR CODE	(3) FEDERAL STOCK NUMBER	(4) PART NUMBER	(5) FSCM	(6) DESCRIPTION	(7) UNIT OF MEAS	(8) QTY INC IN UNIT
(A) FIG NO.	(B) ITEM NO.							
32	23	PADZZ	5961-925-3777	2N2907A	81349	TRANSISTOR	EA	3
32	24	PADZZ	5961-022-5670	2N3439	81349	TRANSISTOR	EA	1
32	25	PADZZ	5905-957-8633	RN60D51R1F	81349	RESISTOR, FIXED, FILM	EA	2
32	26	PADZZ	5905-721-2385	RN60D3322F	81349	RESISTOR, FIXED, FILM	EA	2
32	27	PADZZ	5905-138-1285	RN60D2001F	81349	RESISTOR, FIXED, FILM	EA	2
32	28	PADZZ	5905-211-0780	RN60D2211F	81349	RESISTOR, FIXED, FILM	EA	3
32	29	PADZZ	5905-983-6914	RN60D1002F	81349	RESISTOR, FIXED, FILM	EA	13
32	30	PADZZ	5905-760-6456	RN60D1182F	81349	RESISTOR, FIXED, FILM	EA	1
32	31	PADZZ	5905-758-4840	RN60D1501F	81349	RESISTOR, FIXED, FILM	EA	3
32	32	PADZZ	5905-489-2151	RT24C2P103	81349	RESISTOR, VARIABLE, WIREWOUND	EA	1
32	33	PADZZ	5905-025-5988	RN60D3321F	81349	RESISTOR, FIXED, FILM	EA	3
32	34	PADZZ	5905-195-6377	RN60D1502F	81349	RESISTOR, FIXED, FILM	EA	3
32	35	PADZZ	5905-432-6410	RN60D1001F	81349	RESISTOR, FIXED, FILM	EA	8
32	36	PADZZ	5905-892-6578	RN60D1212F	81349	RESISTOR, FIXED, FILM	EA	-
32	37	PADZZ	5905-702-9485	RN60D22R1F	81349	RESISTOR, FIXED, FILM	EA	2
32	38	PADZZ	5905-813-8623	RN65D4750F	81349	RESISTOR, FIXED, FILM	EA	2
32	39	PADZZ	5905-194-1695	RN60D4751F	81349	RESISTOR, FIXED, FILM	EA	1
32	40	PADZZ	5905-147-2062	RN60D2212F	81349	RESISTOR, FIXED, FILM	EA	1
GROUP 2A1A13 STORAGE TUBE PROTECT,								
LOADS AND VIDEO AMPLIFIER								
33	1	PADZZ	5910-010-8718	CK06BX103K	81349	CAPACITOR, FIXED, CERAMIC DIELECTRIC	EA	2
33	2	PADZZ	5910-144-4383	CSR13F226KL	81349	CAPACITOR, FIXED, ELECTROLYTIC	EA	2
33	3	PADZZ	5910-107-4241	CK06BX122K	81349	CAPACITOR, FIXED, CERAMIC DIELECTRIC	EA	1
33	4	PADZZ	5910-113-9453	CK06BX105K	81349	CAPACITOR, FIXED, CERAMIC DIELECTRIC	EA	2
33	5	PADZZ	5910-113-5499	CK06BX104K	81349	CAPACITOR, FIXED, CERAMIC DIELECTRIC	EA	2
33	6	PADZZ	5961-842-9864	1N914	81349	SEMICONDUCTOR DEVICE, DIODE	EA	2
33	7	PADZZ	5961-919-4224	7717-44N	13103	INSULATOR, DISK	EA	7
33	8	XBHFF	5961-951-5474	10105DAP	07047	INSULATOR, PLATE	EA	1
33	9	PADZZ	5945-478-7662	EA1B131	35344	RELAY, ARMATURE	EA	1
33	10	PADZZ	5950-727-2680	MS75052-5	96906	COIL, RADIO FREQUENCY	EA	2
33	11	PADZZ	5935-242-2071	UPCCS#23AAEK	97954	CONNECTOR, RECEPTACLE, ELECTRICAL	EA	1
33	12	PADZZ	5961-925-3777	2N2907A	81349	TRANSISTOR	EA	2
33	13	PADZZ	5961-951-8757	2N2222A	81349	TRANSISTOR	EA	3
33	14	PADZZ	5961-949-1432	2N2219A	81349	TRANSISTOR	EA	1
33	15	PADZZ	5961-949-1440	2N2905A	81349	TRANSISTOR	EA	1
33	16	PADZZ	5905-978-7113	RN65D10R0F	81349	RESISTOR, FIXED, FILM	EA	4
33	17	PADZZ	5905-957-8633	RN60D51R1F	81349	RESISTOR, FIXED, FILM	EA	4
33	18	PADZZ	5905-211-0230	RN60D2211F	81349	RESISTOR, FIXED, FILM	EA	4
33	19	PADZZ	5905-983-6914	RN60D1002F	81349	RESISTOR, FIXED, FILM	EA	9
33	20	PADZZ	5905-189-2474	RN60D4750F	81349	RESISTOR, FIXED, FILM	EA	2
33	21	PADZZ	5905-758-4840	RN60D1501F	81349	RESISTOR, FIXED, FILM	EA	1
33	22	PADZZ	5905-702-9485	RN60D22R1F	81349	RESISTOR, FIXED, FILM	EA	1
33	23	PADZZ	5905-137-0804	RN60D1003F	81349	RESISTOR, FIXED, FILM	EA	1

SEE NOTE 3

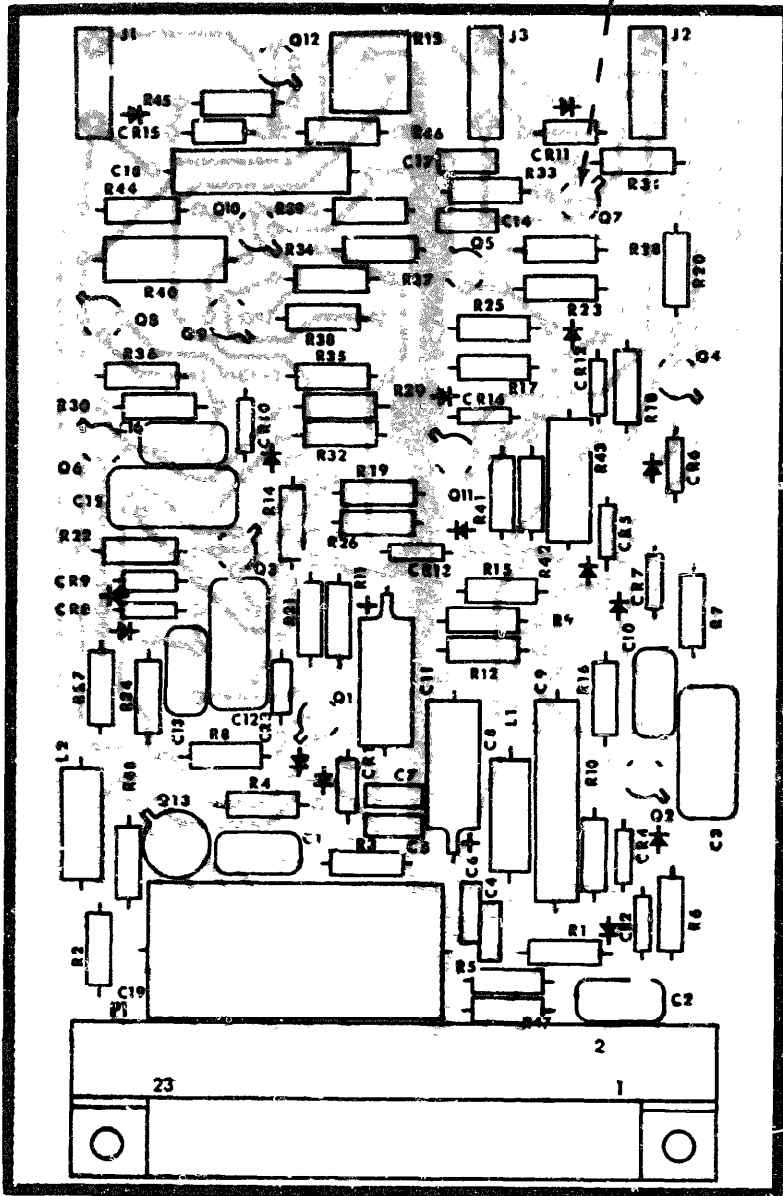

REF DES.	ITEM NO.	REF DES.	ITEM NO.	REF DES.	ITEM NO.	REF DES.	ITEM NO.
C1	1	E4	16	R10	29	R30	34
C2	1	E5	16	R11	31	R31	34
C3	2	E6	16	R12	28	R32	29
C4	3	E7	16	R13	32	R33	35
C5	3	E8	16	R14	33	R34	33
C6	4	E9	16	R15	29	R35	35
C7	4	E10	16	R16	34	R36	29
C8	5	E11	16	R17	33	R37	35
C9	6	E12	16	R18	35	R38	29
C10	7	E13	16	R19	31	R39	35
C11	5	J1	17	R20	29	R40	38
C12	8	J2	18	R21	36	R41	35
C13	9	J3	19	R22	29	R42	39
C14	10	L1	20	R23	29	R43	38
C15	2	L2	20	R24	29	R44	37
C16	9	P1	21	R25	29	R45	31
C17	10	Q1	22	R26	29	R46	35
C18	11	Q2	22	R27	29	R47	40
C19	12	Q3	22	R28	37	R48	35
CR1	13	Q4	22	R29	28		
CR2	13	Q5	23				
CR3	14	Q6	22				
CR4	13	Q7	22				
CR5	13	Q8	22				
CR6	13	Q9	23				
CR7	13	Q10	23				
CR8	13	Q11	22				
CR9	14	Q12	22				
CR10	13	Q13	24				
CR11	15	R1	25				
CR12	13	R2	25				
CR13	13	R3	26				
CR14	13	R4	27				
CR15	15	R5	26				
E1	16	R6	27				
E2	16	R7	28				
E3	16	R8	29				
		R9	30				

LEGEND

BASING DIAGRAMS ARE SHOWN FROM THE TOP AS ON THE PART LOCATION DIAGRAM.

TRANSISTOR (Q)

NOTE:

1. LIGHT SHADING INDICATES ETCHED SIDE CIRCUIT PATTERN-DARK SHADING INDICATES COMPONENT SIDE PATTERN.
2. FOR COMPLETE REFERENCE DESIGNATION PREFIX WITH 2A1A12
3. EACH TRANSISTOR (Q1 THROUGH Q13) IS MOUNTED ON AN INSULATOR DISK (E1 THROUGH E13).

EL6625-1824-40P-TM-32

Figure 32. Sweep and Blanking, generator Cs-Vc

SECTION II REPAIR PARTS LIST (CONTINUED)

(1) ILLUSTRATION		(2) SMR CODE	(3) FEDERAL STOCK NUMBER	(4) PART NUMBER	(5) FSCM	(6) DESCRIPTION	(7) UNIT OF MEAS	(8) QTY INC IN UNIT
(A) FIG NO.	(B) ITEM NO.							
33	24	PADZZ	5905-432-6410	RN60D1001F	81349	RESISTOR, FIXED, FILM	EA	1
33	25	PADZZ	5905-763-9309	RN60D39R2F	81349	RESISTOR, FIXED, FILM	EA	1
GROUP 2A1A14 POWER SUPPLY, +15VDC								
34	1	PADZZ	5910-113-5540	CK15BX104K	81349	CAPACITOR, FIXED, CERAMIC DIELECTRIC	EA	7
34	2	PADZZ	5910-887-9874	CUL13CHJ31SP3	81349	CAPACITOR, FIXED, ELECTROLYTIC	EA	1
34	3	PADZZ	5910-460-0869	CM05FD221J03	81349	CAPACITOR, FIXED, MICA DIELECTRIC	EA	1
34	4	PADZZ	5910-010-8718	CK06BX103K	81349	CAPACITOR, FIXED, CERAMIC DIELECTRIC	EA	1
34	5	PADZZ	5910-165-2742	CL21BN080SPE	81349	CAPACITOR, FIXED, ELECTROLYTIC	EA	1
34	6	PADZZ	5961-762-0201	1N5550	81349	SEMICONDUCTOR DEVICE, DIODE	EA	6
34	7	PADZZ	5961-836-6667	1N816	81349	SEMICONDUCTOR DEVICE, DIODE	EA	2
34	8	PADZZ	5961-842-9864	1N914	81349	SEMICONDUCTOR DEVICE, DIODE	EA	2
34	9	PADZZ	5961-923-3940	1N825	81349	SEMICONDUCTOR DEVICE, DIODE	EA	1
34	10	PADZZ	5961-054-0339	7717-19DAP	13103	INSULATOR, DISK	EA	1
34	11	PADZZ	5999-484-5513	7717-18N	13103	INSULATOR, DISK	EA	2
34	12	PADZZ	5935-131-9696	M39024-11-04	81349	JACK, TIP	EA	1
34	13	PADZZ	5935-131-9681	M39024-11-02	81349	JACK, TIP	EA	1
34	14	PADZZ	5935-131-9726	M39024-11-06	81349	JACK, TIP	EA	1
34	15	PADZZ	5935-131-9693	M39024-11-03	81349	JACK, TIP	EA	1
34	16	PADZZ	5935-259-3880	UPCCSGM23AACL	97954	CONNECTOR, RECEPTACLE, ELECTRICAL	EA	1
34	17	PADZZ	5961-913-1747	2N2907	81349	TRANSISTOR	EA	1
34	18	PADZZ	5961-951-8757	2N2222A	81349	TRANSISTOR	EA	1
34	19	PADZZ	5905-432-6410	RN60D1001F	81349	RESISTOR, FIXED, FILM	EA	4
34	20	PADZZ	5905-983-6914	RN60D1002F	81349	RESISTOR, FIXED, FILM	EA	2
34	21	PADZZ	5905-758-2063	RN60D2210F	81349	RESISTOR, FIXED, FILM	EA	1
34	22	PADZZ	5905-138-1285	RN60D2001F	81349	RESISTOR, FIXED, FILM	EA	2
34	23	PADZZ	5905-763-9237	RW65VR33	81349	RESISTOR, FIXED, WIREWOUND	EA	1
34	24	PADZZ	5905-758-4840	RN60D1501F	81349	RESISTOR, FIXED, FILM	EA	1
34	25	PADZZ	5905-409-7252	RN60C2611F	81349	RESISTOR, FIXED, FILM	EA	1
34	26	PADZZ	5905-196-1020	RT24C2P501	81349	RESISTOR, VARIABLE, WIREWOUND	EA	1
34	27	PADZZ	5905-451-7518	RN60C1961F	81349	RESISTOR, FIXED, FILM	EA	1
34	28	PADZZ	5962-148-2858	SN52709L	01295	INTEGRATED CIRCUIT, OPERATIONAL AMPLIFIER	EA	1
34	29	PADZZ	5940-725-9498	SE12XC07	81349	TERMINAL, STUD	EA	12
GROUP 2A1A15 ASSEMBLY, HEATSINK								
35	1	PAHZZ	5940-905-4576	SE209D01	81349	TERMINAL, STUD	EA	3
35	2	PAHZZ	5940-050-2308	MS35431-3	96906	TERMINAL, LUG	EA	1
35	3	XBHFF	5961-767-1522	BBT0-3-62	05451	INSULATOR, PLATE	EA	1
35	4	PAHZZ	5935-490-3743	M24398-4-2	81349	CONNECTOR, PLUG, ELECTRICAL	EA	1
35	5	PAHZZ	5961-115-9923	2N3846	81349	TRANSISTOR	EA	1
35	6	PAHZZ	5961-923-3951	2N2151	81349	TRANSISTOR	EA	1
35	7	PAHZZ	5961-085-0468	JN3902	81349	TRANSISTOR	EA	1
35	8	PADZZ	5905-983-6914	RN60D1002F	81349	RESISTOR, FIXED, FILM	EA	1
GROUP 2W CABLE ASSEMBLIES								
36	1	PAHZZ	5935-726-6487	MS3126F20-41P	96906	CONNECTOR, PLUG, ELECTRICAL	EA	1

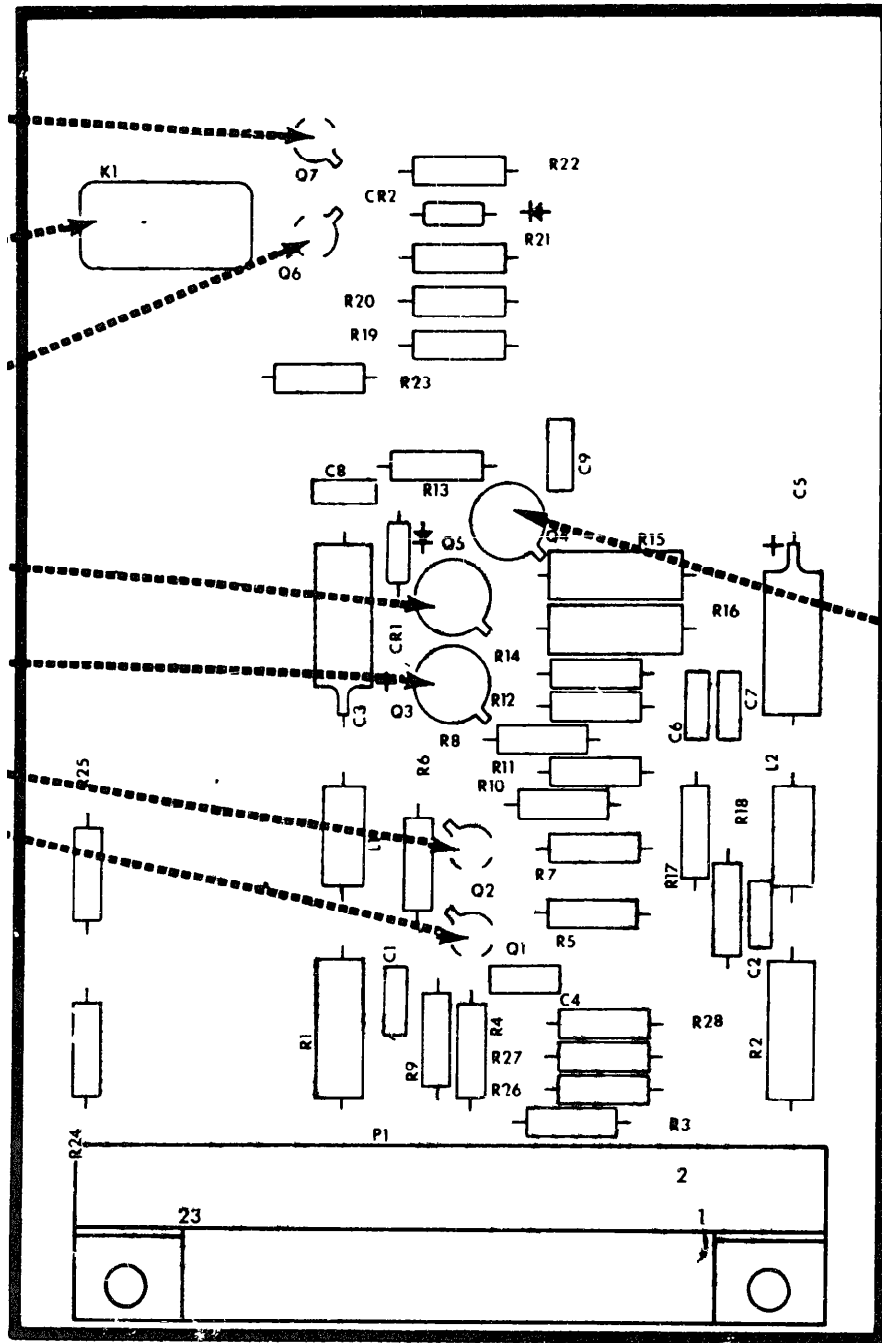

REF DES	ITEM NO	REF DES	ITEM NO	REF DES	ITEM NO	REF DES	ITEM NO	REF DES	ITEM NO	REF DES	ITEM NO
C1	1	CR2	6	L1	10	R1	16	R11	18	R21	24
C2	1	E1	7	L2	10	R2	16	R12	21	R22	19
C3	2	E2	7	PI	11	R3	17	R13	18	R23	25
C4	3	E3	7	Q1	12	R4	17	R14	22	R24	19
C5	2	E4	7	Q2	12	R5	18	R15	16	R25	19
C6	4	E5	7	Q3	13	R6	19	R16	16	R26	19
C7	4	E6	7	Q4	14	R7	18	R17	19	R27	19
C8	5	E7	7	Q5	15	R8	20	R18	17	R28	19
C9	5	E8	8	Q6	13	R9	20	R19	23		
CR1	6	K1	9	Q7	13	R10	17	R20	19		

LEGEND

BASING DIAGRAMS ARE SHOWN FROM THE TOP AS ON THE PART LOCATION DIAGRAM.

TRANSISTOR (Q)

NOTE:

1. BASING DIAGRAMS FOR RELAYS ARE ILLUSTRATED ON THE RELAY CASE.
2. LIGHT SHADING INDICATES ETCHED SIDE CIRCUIT PATTERN-DARK SHADING INDICATES COMPONENT SIDE PATTERN.
3. FOR COMPLETE REFERENCE DESIGNATION PREFIX WITH 2A1A13
4. EI THROUGH E8 ARE INSULATOR DISKS MOUNTED UNDER THE COMPONENTS AS INDICATED

Figure 33. Storage tube protect, loads and video amplifier

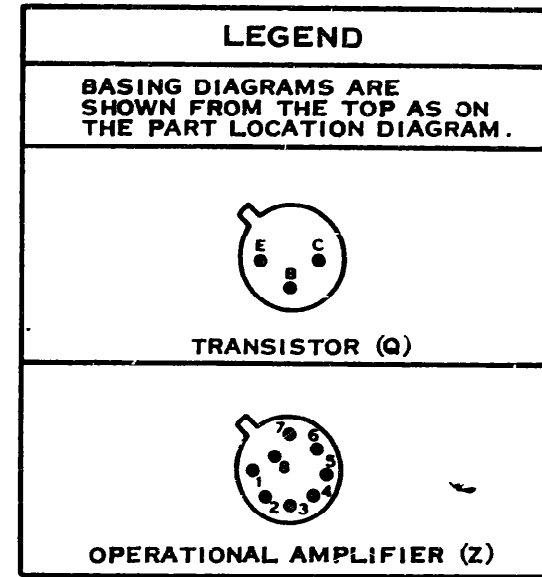
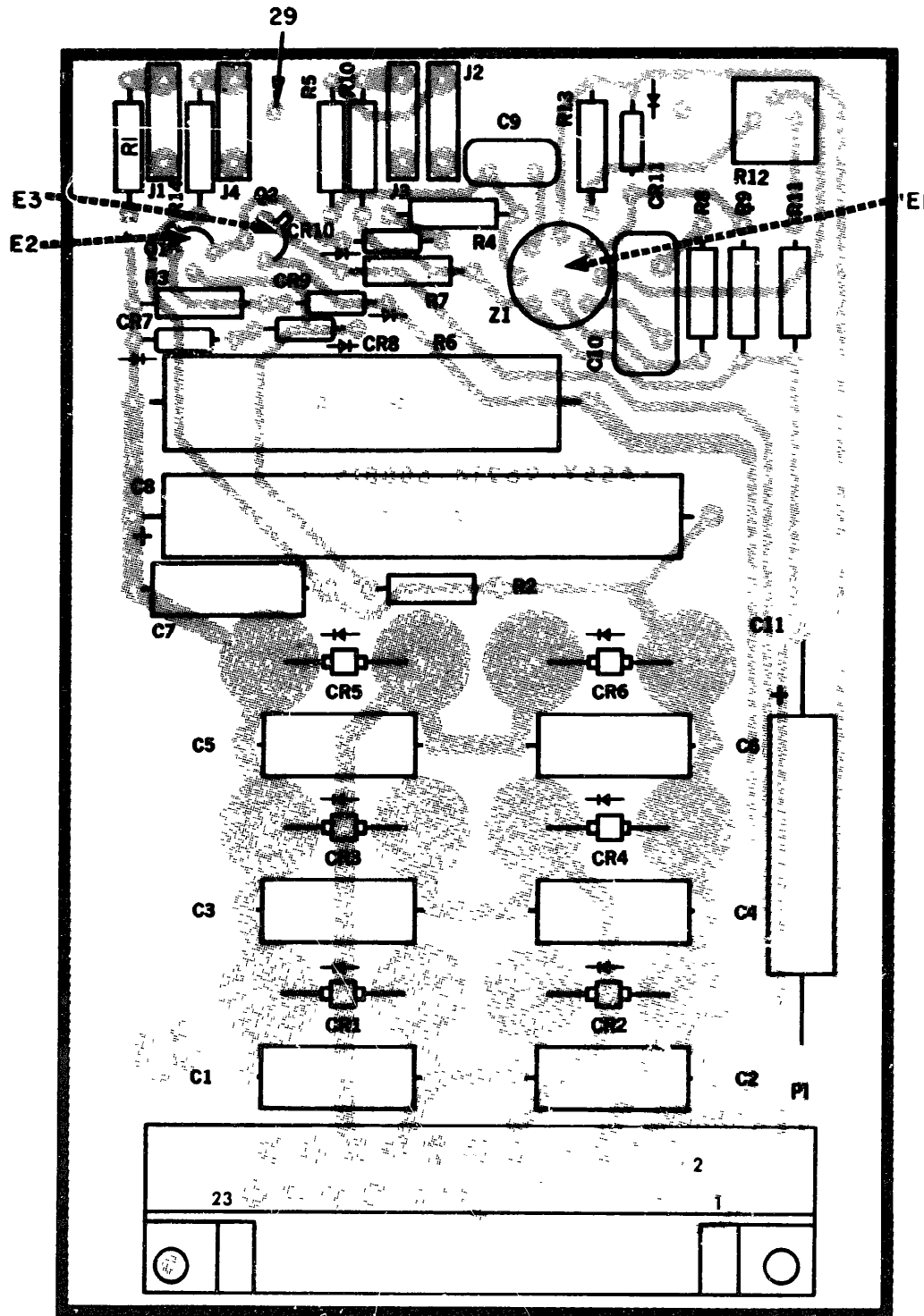

REF DES	ITEM NO	REF DES	ITEM NO	REF DES	ITEM NO	REF DES	ITEM NO	REF DES	ITEM NO
C1	1	C11	5	CR10	8	Q1	17	R9	22
C2	1	CR1	6	CR11	9	Q2	18	R10	19
C3	1	CR2	6	E1	10	R1	19	R11	25
C4	1	CR3	6	E2	11	R2	20	R12	26
C5	1	CR4	6	E3	11	R3	21	R13	27
C6	1	CR5	6	J1	12	R4	22	R14	19
C7	1	CR6	6	J2	13	R5	19	Z1	28
C8	2	CR7	7	J3	14	R6	23		
C9	3	CR8	7	J4	15	R7	20		
C10	4	CR9	8	P1	16	R8	24		

NOTE:

1. LIGHT SHADING INDICATES ETCHED SIDE CIRCUIT PATTERN—DARK SHADING INDICATES COMPONENT SIDE PATTERN.
2. FOR COMPLETE REFERENCE DESIGNATION PREFIX WITH 2A1A14.
3. E1, E2, AND E3 ARE INSULATOR DISKS LOCATED UNDER THE COMPONENTS AS INDICATED

Figure 34. Power supply, +15 Vdc

REF DES	ITEM NO
E1	1
E2	1
E3	1
E4	2
E5	3
J1	4
Q1	5
Q2	6
Q3	7
R1	8

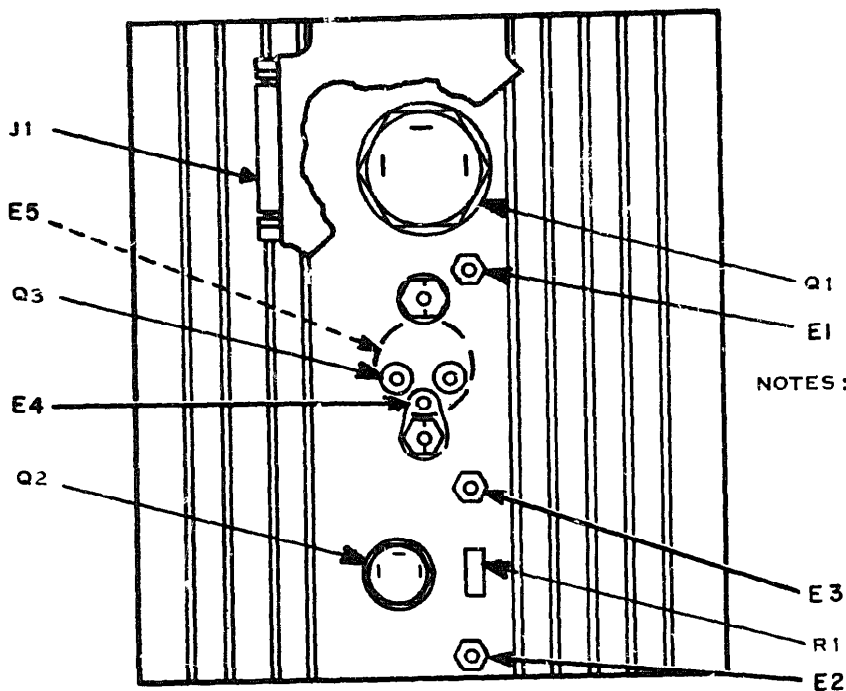

NOTES: 1. FOR COMPLETE REFERENCE DESIGNATOR PREFIX WITH 2A1A15

EL6625-1824-40P-TM-35

Figure 35. Assembly, heatsink 2A1A15

SECTION II REPAIR PARTS LIST (CONTINUED)

(1) ILLUSTRATION		(2) SMR CODE	(3) FEDERAL STOCK NUMBER	(4) PART NUMBER	(5) FSCM	(6) DESCRIPTION	(7) UNIT OF MEAS	(8) QTY INC IN UNIT
(A) FIG NO.	(B) ITEM NO.							
36	✓	PAOOD	6625-489-2671	CX12437/AAM-35	80058	CABLE ASSEMBLY, SPECIAL PURPOSE, ELECTRICAL	EA	-
36	2	PAHZZ	5935-724-7592	MS3126F22-4LS	96906	CONNECTOR, PLUG, ELECTRICAL	EA	-
36	4	PAHZZ	5935-497-0927	L22TF95S6Y1	09922	CONNECTOR, PLUG, ELECTRICAL	EA	-
36	5	PAOOD	6625-489-0467	CX12438/AAM-35	80058	CABLE ASSEMBLY, SPECIAL PURPOSE, ELECTRICAL	EA	-
36	6	PAHZZ	5935-497-0925	L22TF95P6X1	09922	CONNECTOR, PLUG, ELECTRICAL	EA	-
36	7	PAHZZ	5935-902-1817	MS3126F22-55PY	96906	CONNECTOR, PLUG ELECTRICAL	EA	-
36	8	PAOOD	6625-242-5797	CX12439/AAM-35	80058	CABLE ASSEMBLY, SPECIAL PURPOSE, ELECTRICAL	EA	-
36	9	PAHZZ	5935-724-7581	MS3126F22-55SW	96906	CONNECTOR, PLUG, ELECTRICAL	EA	-
36	10	PAHZZ	5935-238-0610	L22TF95P6W1	09922	CONNECTOR, PLUG, ELECTRICAL	EA	-
36	11	PAOOD	6625-489-6140	CX12440/AAM-35	80058	CABLE ASSEMBLY, SPECIAL PURPOSE, ELECTRICAL	EA	-
36	12	PAHZZ	5935-424-0935	L22TF95S6W1	09922	CONNECTOR, PLUG, ELECTRICAL	EA	-

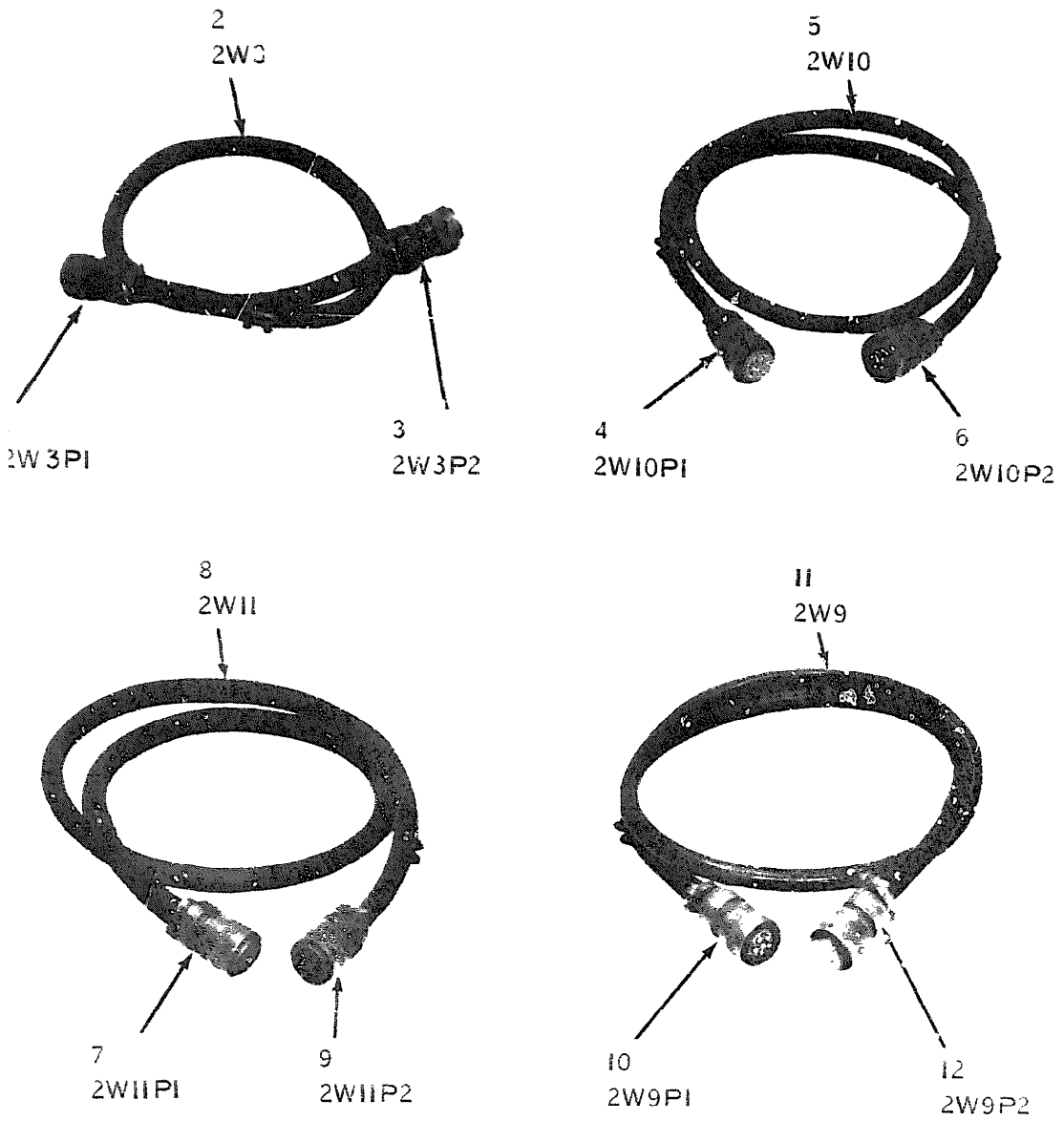

EL 6625 1824 - 40P - TM - 36

Figure 36. Cable assemblies 2W

SECTION IV FEDERAL STOCK NUMBER AND PART NUMBER INDEX

STOCK NUMBER	FIG NO.	ITEM NO.	STOCK NUMBER	FIG NO.	ITEM NO.
5355-567-8589	3	77	5905-138-1285	12	18
5355-567-8589	20	62	5905-138-1285	23	47
5355-985-6888	3	76	5905-138-1285	24	31
5355-985-6888	20	61	5905-138-1285	25	37
5835-243-8493	20	43	5905-138-1285	26	35
5835-243-8494	20	39	5905-138-1285	27	27
5905-004-6103	8	21	5905-138-1285	28	36
5905-006-6988	29	43	5905-138-1285	29	45
5905-006-6988	30	35	5905-138-1285	30	34
5905-025-5984	8	24	5905-138-1285	31	36
5905-025-5987	25	36	5905-138-1285	32	27
5905-025-5987	29	36	5905-138-1285	34	22
5905-025-5987	30	41	5905-142-0901	10	14
5905-025-5988	27	30	5905-142-0901	11	13
5905-025-5988	30	46	5905-142-0901	24	41
5905-025-5988	32	33	5905-142-0901	25	54
5905-028-1832	5	28	5905-142-0901	26	31
5905-036-8778	30	40	5905-142-0901	27	31
5905-051-5557	7	15	5905-142-0901	28	27
5905-057-5089	3	33	5905-142-0901	29	35
5905-058-1770	29	44	5905-142-0901	30	39
5905-067-5576	23	33	5905-142-0901	31	22
5905-067-7338	8	28	5905-142-0903	27	57
5905-069-3913	23	42	5905-142-0931	13	5
5905-069-3913	25	40	5905-142-0931	26	28
5905-069-3913	28	33	5905-147-0269	27	46
5905-069-3917	21	15	5905-147-2062	27	52
5905-069-3917	30	43	5905-147-2062	30	50
5905-071-2315	3	65	5905-147-2062	32	40
5905-078-8293	30	52	5905-153-0135	8	22
5905-078-8365	9	19	5905-165-3105	25	56
5905-078-8365	25	30	5905-175-8541	29	56
5905-079-3500	9	27	5905-176-2398	31	21
5905-079-6336	5	35	5905-184-7794	24	39
5905-079-6336	24	43	5905-189-2454	23	48
5905-079-6336	27	28	5905-189-2454	25	35
5905-099-0545	30	32	5905-189-2454	27	33
5905-101-2326	27	36	5905-189-2454	28	31
5905-104-0922	24	40	5905-189-2456	11	17
5905-104-0922	26	27	5905-189-2467	5	54
5905-104-0922	28	23	5905-189-2467	12	15
5905-110-0950	26	43	5905-189-2467	26	30
5905-112-1233	8	25	5905-189-2467	27	47
5905-112-1661	11	11	5905-189-2472	6	26
5905-112-7056	30	53	5905-189-2474	10	15
5905-121-6327	8	29	5905-189-2474	11	16
5905-137-0804	9	15	5905-189-2474	30	33
5905-137-0804	12	23	5905-189-2474	31	33
5905-137-0804	22	23	5905-189-2474	33	20
5905-137-0804	27	56	5905-189-2479	30	49
5905-137-0804	33	23	5905-192-3458	27	38
5905-137-0806	21	12	5905-192-3479	11	23
5905-138-1283	23	39	5905-192-3479	24	44
5905-138-1283	29	48	5905-192-3474	28	34
5905-138-1285	4	22	5905-192-3479	30	26
5905-138-1285	5	30	5905-192-3876	30	48
5905-138-1285	6	23	5905-192-3880	9	22
5905-138-1285	10	21	5905-194-1695	6	32
5905-138-1285	11	20	5905-194-1695	12	14

SECTION IV FEDERAL STOCK NUMBER AND PART NUMBER INDEX (CONTINUED)

STOCK NUMBER	FIG. NO.	ITEM NO.	STOCK NUMBER	FIG. NO.	ITEM NO.
5905-194-1695	22	22	5905-251-7581	25	39
5905-194-1695	27	34	5905-255-3664	30	28
5905-194-1695	28	35	5905-255-3664	31	23
5905-194-1695	29	30	5905-256-5051	8	30
5905-194-1695	32	39	5905-261-7693	5	32
5905-194-2324	27	50	5905-261-7693	26	25
5905-195-6377	26	39	5905-261-7693	30	30
5905-195-6377	27	39	5905-402-0945	28	24
5905-195-6377	29	52	5905-403-3147	6	35
5905-195-6377	32	34	5905-404-8782	29	40
5905-195-6379	11	27	5905-405-0955	5	36
5905-195-6379	23	46	5905-405-1171	20	5
5905-195-6379	29	54	5905-407-2160	25	34
5905-195-6379	30	44	5905-409-7252	4	25
5905-195-6384	9	25	5905-409-7252	34	25
5905-195-6384	10	19	5905-410-7428	17	1
5905-195-6384	27	44	5905-412-4049	8	31
5905-195-6404	12	16	5905-414-2545	3	11
5905-195-6404	29	51	5905-424-9312	7	20
5905-195-6404	31	31	5905-424-9312	30	31
5905-196-1020	4	26	5905-432-0468	6	25
5905-196-1020	34	26	5905-432-0468	25	58
5905-197-3172	6	33	5905-432-6410	4	19
5905-197-3172	11	17	5905-432-6410	5	26
5905-197-3172	27	43	5905-432-6410	6	29
5905-208-3800	6	36	5905-432-6410	9	23
5905-208-3800	21	16	5905-432-6410	10	24
5905-208-3800	22	28	5905-432-6410	11	14
5905-208-3800	23	28	5905-432-6410	12	21
5905-208-3800	24	35	5905-432-6410	21	18
5905-208-3800	27	51	5905-432-6410	22	24
5905-208-3800	31	32	5905-432-6410	23	32
5905-211-0230	26	24	5905-432-6410	24	29
5905-211-0230	27	41	5905-432-6410	25	49
5905-211-0230	29	41	5905-432-6410	26	40
5905-211-0230	32	28	5905-432-6410	27	29
5905-211-0230	33	18	5905-432-6410	28	29
5905-223-2741	8	26	5905-432-6410	29	37
5905-225-9390	6	24	5905-432-6410	30	36
5905-225-9756	3	34	5905-432-6410	31	25
5905-227-5072	26	33	5905-432-6410	32	35
5905-227-5072	9	17	5905-432-6410	33	24
5905-229-7824	29	53	5905-432-6410	34	19
5905-232-7791	5	38	5905-432-6411	21	11
5905-232-7791	29	50	5905-432-6411	25	33
5905-232-7808	30	24	5905-432-6411	28	32
5905-232-7808	31	20	5905-432-9159	29	57
5905-233-6848	20	4	5905-432-9189	3	16
5905-233-7141	5	33	5905-448-9360	28	25
5905-233-7141	13	6	5905-451-7518	4	27
5905-233-7141	26	38	5905-451-7518	34	27
5905-242-2047	25	47	5905-451-7522	25	51
5905-242-2048	25	48	5905-451-7532	23	41
5905-242-2640	25	46	5905-451-7532	24	32
5905-242-2641	25	55	5905-451-7532	27	54
5905-243-5622	26	32	5905-451-7532	29	47
5905-243-5622	29	49	5905-451-7533	27	53
5905-243-8473	20	6	5905-451-7534	10	22
5905-243-9030	9	16	5905-451-7534	26	41

SECTION IV FEDERAL STOCK NUMBER AND PART NUMBER INDEX (CONTINUED)

STOCK NUMBER	FIG NO.	ITEM NO.	STOCK NUMBER	FIG NO.	ITEM NO.
5905-452-0742	31	35	5905-758-3446	12	13
5905-452-0743	26	42	5905-758-4840	4	24
5905-452-0756	11	19	5905-758-4840	5	27
5905-452-0768	7	16	5905-758-4840	6	28
5905-452-0768	12	22	5905-758-4840	9	24
5905-452-0768	31	24	5905-758-4840	11	24
5905-452-0769	21	13	5905-758-4840	23	30
5905-452-0773	22	27	5905-758-4840	24	42
5905-452-0773	23	45	5905-758-4840	25	32
5905-452-0773	25	44	5905-758-4840	27	35
5905-452-0773	25	53	5905-758-4840	28	26
5905-452-0773	29	55	5905-758-4840	29	33
5905-452-0773	30	47	5905-758-4840	31	27
5905-455-0809	7	21	5905-758-4840	32	31
5905-468-5847	5	37	5905-758-4840	33	21
5905-477-9176	8	23	5905-758-4840	34	24
5905-480-5196	8	27	5905-760-6456	32	30
5905-482-0618	5	39	5905-761-1905	27	48
5905-489-2151	22	26	5905-763-6653	26	34
5905-489-2151	23	35	5905-763-9237	4	23
5905-489-2151	24	34	5905-763-9237	34	23
5905-489-2151	25	52	5905-763-9309	26	37
5905-489-2151	27	32	5905-763-9309	33	25
5905-489-2151	28	30	5905-764-1182	30	42
5905-489-2151	29	42	5905-764-2615	20	52
5905-489-2151	32	32	5905-767-0978	31	29
5905-496-5253	8	19	5905-767-0983	25	42
5905-552-2588	20	56	5905-767-0984	30	51
5905-581-1007	30	38	5905-811-4372	20	57
5905-682-7773	12	17	5905-813-8623	32	38
5905-682-7773	20	50	5905-838-8399	3	10
5905-682-7773	26	36	5905-851-9540	3	56
5905-689-1966	25	41	5905-851-9540	20	58
5905-702-9485	10	18	54905-857-6107	30	25
5905-702-9485	32	37	5905-868-4366	3	25
5905-702-9485	33	22	5905-883-9168	3	4
5905-707-4872	27	49	5905-892-6578	11	18
5905-707-4872	31	30	5905-892-6578	21	17
5905-721-2348	23	36	5905-892-6578	23	31
5905-721-2385	6	27	5905-892-6578	24	37
5905-721-2385	11	25	5905-892-6578	25	43
5905-721-2385	12	20	5905-892-6578	32	36
5905-721-2385	24	33	5905-892-7001	29	46
5905-721-2385	27	45	5905-899-3111	3	35
5905-721-2385	30	45	5905-914-9254	10	17
5905-721-2385	32	26	5905-926-8630	8	20
5905-721-2387	9	21	5905-934-3134	3	26
5905-721-2387	29	39	5905-945-7053	6	22
5905-728-7855	3	32	5905-947-5641	8	32
5905-732-3859	22	20	5905-951-5717	30	37
5905-732-3859	23	38	5905-951-5717	31	26
5905-752-3600	25	57	5905-952-6854	23	34
5905-758-2063	4	21	5905-957-8633	7	18
5905-758-2063	10	23	5905-957-8633	10	16
5905-758-2063	24	28	5905-957-8633	23	27
5905-758-2063	25	45	5905-957-8633	24	36
5905-758-2063	27	40	5905-957-8633	25	31
5905-758-2063	29	38	5905-957-8633	26	23
5905-758-2063	34	21	5905-957-8633	27	37

SECTION IV FEDERAL STOCK NUMBERS AND PARTS NUMBER INDEX (CONTINUED)

STOCK NUMBER	FIG. NO.	ITEM NO.	STOCK NUMBER	FIG. NO.	ITEM NO.
5905-957-8633	29	28	5910-007-2003	27	6
5905-957-8633	31	34	5910-007-2003	29	3
5905-957-8633	32	25	5910-010-8718	4	4
5905-957-8633	33	17	5910-010-8718	6	5
5905-969-5846	23	44	5910-010-8718	8	2
5905-969-5846	29	32	5910-010-8718	10	2
5905-972-4687	5	25	5910-010-8718	11	1
5905-973-7113	33	16	5910-010-8718	23	9
5905-983-6914	4	20	5910-010-8718	24	1
5905-983-6914	5	31	5910-010-8718	25	5
5905-983-6914	6	30	5910-010-8718	26	2
5905-983-6914	7	17	5910-010-8718	27	1
5905-9836914	9	26	5910-010-8718	28	1
5905-983-6914	10	20	5910-010-8718	29	1
5905-983-6914	11	21	5910-010-8718	30	1
5905-983-6914	12	12	5910-010-8718	31	2
5905-983-6914	13	4	5910-010-8718	32	3
5905-983-6914	14	2	5910-010-8718	33	1
5905-983-6914	15	7	5910-010-8718	34	4
5905-983-6914	20	51	5910-050-2940	29	7
5905-983-6914	21	14	5910-051-2232	21	1
5905-983-6914	22	25	5910-060-1190	32	8
5905-983-6914	23	29	5910-079-5253	23	4
5905-983-6914	24	30	5910-079-5253	24	7
5905-983-6914	25	38	5910-082-4898	26	6
5905-983-6914	26	29	5910-088-1146	32	1
5905-983-6914	27	42	5910-096-4644	22	9
5905-983-6914	29	29	5910-107-4241	33	3
5905-983-6914	30	29	5910-112-4337	9	4
5905-983-6914	31	28	5910-113-5376	9	6
5905-983-6914	32	29	5910-113-5445	9	5
5905-983-6914	33	19	5910-113-5499	5	1
5905-983-6914	34	20	5910-113-5499	6	6
5905-983-6914	35	8	5910-113-5499	32	4
5905-984-7679	23	40	5910-113-5499	33	5
5905-984-7681	13	3	5910-113-5540	4	1
5905-984-7681	23	43	5910-113-5540	5	2
5905-984-7681	24	38	5910-113-5540	7	1
5905-984-7681	25	50	5910-113-5540	28	5
5905-984-7681	27	55	5910-113-5540	31	6
5905-984-7681	29	34	5910-113-5540	34	1
5905-988-2309	12	11	5910-113-5689	12	2
5905-988-2309	22	21	5910-113-5689	22	2
5905-988-2310	9	18	5910-113-5689	24	2
5905-988-2310	11	15	5910-113-9453	6	2
5905-988-2310	12	19	5910-113-9453	32	10
5905-988-2310	26	26	5910-113-9453	33	4
5905-988-2310	28	28	5910-136-1037	27	11
5905-988-2310	30	27	5910-136-1037	28	6
5905-988-2313	6	31	5910-143-0501	8	4
5905-988-2313	23	37	5910-143-0501	11	2
5905-988-2313	28	22	5910-144-4379	5	7
5905-989-9362	7	19	5910-144-4383	6	3
5905-990-4152	5	29	5910-144-4383	23	2
5905-997-2182	9	20	5910-144-4383	32	5
5905-998-9178	6	34	5910-144-4383	33	2
5905-998-9178	29	31	5910-154-0547	12	1
5910-006-6972	5	3	5910-154-0547	22	1
5910-007-2000	25	8	5910-154-0547	23	3
5910007-2001	28	4			

SECTION IV FEDERAL STOCK NUMBER AND PART NUMBER INDEX (CONTINUED)

STOCK NUMBER	FIG NO.	ITEM NO.	STOCK NUMBER	FIG. NO.	ITEM NO.
5910-154-0547	24	5	5910-487-8424	26	7
5910-154-0547	27	8	5910-490-0397	5	4
5910-163-2189	22	8	5910-490-0397	6	4
5910-164-2031	22	7	5910-490-0397	10	3
5910-165-2742	4	5	5910-490-0397	30	5
5910-165-2742	34	5	5910-495-0042	8	3
5910-172-1381	7	2	5910-717-3539	25	9
5910-176-7335	22	5	5910-725-4794	27	9
5910-211-2503	6	7	5910-725-4794	30	4
5910-229-7757	23	5	5910-761-7112	22	6
5910-229-7757	24	6	5910-762-7886	22	3
5910-229-7757	27	4	5910-777-6910	10	1
5910-229-7786	30	2	5910-777-6919	27	7
5910-229-7786	31	1	5910-781-1154	22	4
5910-236-8740	23	7	5910-822-5683	7	3
5910-236-8740	25	10	5910-822-5683	21	3
5910-236-8740	29	6	5910-832-8080	30	3
5910-402-9247	29	2	5910-835-2734	9	2
5910-410-9329	9	3	5910-850-0552	17	9
5910-410-9329	12	4	5910-850-1205	24	3
5910-410-9329	23	1	5910-887-9874	4	2
5910-410-9329	24	4	5910-887-9874	34	2
5910-410-9329	25	1	5910-902-0031	9	1
5910-410-9329	26	4	5910-913-1096	27	10
5910-410-9329	27	5	5910-934-2564	23	6
5910-410-9329	30	6	5910-934-2564	25	6
5910-410-9329	32	2	5910-936-1332	5	6
5910-442-5005	32	12	5910-936-1332	8	1
5910-450-5239	32	6	5910-936-1332	25	2
5910-453-8796	8	5	5910-936-1332	26	1
5910-456-0794	25	7	5910-949-4205	17	10
5910-456-0800	31	4	5910-954-1769	10	4
5910-456-0812	13	1	5910-954-5496	31	5
5910-456-9511	12	3	5910-957-0676	15	1
5910-456-9511	30	7	5910-984-7588	21	2
5910-460-0869	4	3	5915-127-4305	17	5
5910-460-0869	11	3	5915-194-4876	3	1
5910-460-0869	23	10	5915-481-3088	28	38
5910-460-0869	24	8	5915-990-1409	17	7
5910-460-0869	25	4	5925-118-1098	3	49
5910-460-0869	26	3	5925-854-7358	3	44
5910-460-0869	27	3	5920-052-8551	3	63
5910-460-0869	28	3	5930-113-7582	20	55
5910-460-0869	29	5	5930-167-7749	20	31
5910-460-0869	32	9	5930-167-7749	20	54
5910-460-0869	34	3	5930-184-7763	3	54
5910-460-1047	25	11	5930-184-7763	20	60
5910-460-1047	26	5	5930-189-4335	3	68
5910-460-1047	32	7	5930-229-7796	3	52
5910-481-1005	32	11	5930-229-7796	20	27
5910-481-1626	5	5	5930-350-1770	20	32
5910-481-1626	23	8	5930-350-1771	3	64
5910481-1626	25	3	5930-350-1771	20	53
5910-481-1626	27	2	5930-404-8715	20	29
5910-481-1626	28	2	5930-421-8979	3	40
5910-481-1626	29	4	5930-615-7880	3	67
5910-481-1626	31	3	5930-615-9376	20	30
5910-486-4387	12	5	5930-655-1582	3	39
5910-487-8424	6	1	5930-655-1582	20	59

SECTION IV NATIONAL STOCK NUMBER AND PART NUMBER INDEX (CONTINUE)

STOCK NUMBER	FIG. NO.	ITEM NO.	STOCK NUMBER	FIG. NO.	ITEM NO.
5930-685-9520	20	28	5935-131-9726	28	14
5935-131-9680	22	12	5935-131-9726	29	17
5935-131-9681	4	13	5935-131-9726	30	17
5935-131-9681	5	17	5935-131-9726	34	14
5935-131-9681	7	10	5935-131-9727	32	18
5935-131-9681	8	13	5935-131-9728	23	20
5935-131-9681	10	12	5935-131-9728	24	21
5935-131-9681	22	13	5935-131-9728	25	22
5935-131-9681	23	18	5935-131-9728	29	18
5935-131-9681	24	19	5935-198-3903	18	17
5935-131-9681	25	20	5935-236-7719	3	60
5935-131-9681	27	18	5935-236-7722	3	61
5935-131-9681	28	13	5935-236-7726	3	62
5935-131-9681	29	16	5935-236-7727	3	57
5935-131-9681	30	16	5935-236-7729	4	16
5935-131-9681	31	13	5935-236-7729	29	22
5935-131-9681	34	13	5935-236-7731	24	24
5935-131-9693	4	15	5935-236-7732	23	16
5935-131-9693	5	19	5935-236-7833	26	18
5935-131-9693	23	21	5935-236-7834	11	8
5935-131-9693	25	23	5935-236-7835	23	23
5935-131-9693	26	16	5935-236-7836	13	2
5935-131-9693	27	20	5935-238-0610	18	22
5935-131-9693	28	15	5935-238-0610	36	10
5935-131-9693	29	20	5935-242-2024	3	72
5935-131-9693	30	18	5935-242-2060	3	51
5935-131-9693	31	14	5935-242-2062	3	59
5935-131-9693	34	15	5935-242-2064	3	58
5935-131-9696	4	12	5935-242-2068	32	21
5935-131-9696	5	16	5935-242-2071	33	11
5935-131-9696	7	9	5935-243-0935	36	12
5935-131-9696	8	12	5935-243-8474	20	37
5935-131-9696	10	11	5935-243-8475	20	33
5935-131-9696	22	15	5935-243-8486	20	41
5935-131-9696	23	17	5935-243-8489	20	40
5935-131-9696	24	18	5935-243-8492	20	45
5935-131-9696	25	19	5935-243-8498	20	34
5935-131-9696	26	15	5935-243-8501	20	46
5935-131-9696	27	17	5935-243-8504	20	35
5935-131-9696	28	12	5935-243-8505	20	36
5935-131-9696	29	15	5935-243-8510	7	12
5935-131-9696	30	15	5935-243-8517	30	20
5935-131-9696	31	12	5935-256-0730	25	25
5935-131-9696	32	19	5935-256-0735	27	22
5935-131-9696	34	12	5935-259-3880	34	16
5935-131-9697	22	16	5935-260-2686	3	37
5935-131-9697	24	22	5935-260-2686	20	1
5935-131-9697	29	19	5935-260-3644	21	9
5935-131-9697	32	17	5935-402-6933	18	19
5935-131-9726	4	14	5935-4051172	20	47
5935-131-9726	5	18	5935-405-7594	20	25
5935-131-9726	6	16	5935-405-7595	20	23
5935-131-9726	7	11	5935-405-7596	20	42
5935-131-9726	8	14	5935-410-9250	3	5
5935-131-9726	22	14	5935-489-9999	15	2
5935-131-9726	23	19	5935-490-3743	16	2
5935-131-9726	24	20	5935-490-3743	35	4
5935-131-9726	25	21	5935-490-5220	3	31
5935-131-9726	27	19	5935-497-0925	36	6

SECTION IV NATIONAL STOCK NUMBER AND PART NUMBER INDEX (CONTINUED)

STOCK NUMBER	FIG NO	ITEM NO	STOCK NUMBER	FIG NO	ITEM NO
5935-497-0927	36	4	5945-851-2878	10	10
5935-497-0928	18	20	5935-851-2378	26	17
5935-497-0930	3	55	5950-233-6853	30	19
5935-497-0932	20	48	5950-433-2451	17	2
5935-497-0933	3	48	5950-433-2451	17	11
5935-503-5283	18	1	5950-433-2451	17	12
5935-689-1875	3	73	5950-493-9397	3	29
5935-689-1885	3	46	5950-727-2680	25	24
5935-689-1885	3	50	5950-727-2680	32	20
5935-689-1888	8	17	5950-727-2680	33	10
5935-689-1891	5	20	5950-771-2089	23	22
5935-702-4199	3	3	5950-771-2089	24	23
5935-702-4199	20	2	5950-771-2089	27	21
5935-724-7567	18	13	5950-771-2089	29	21
5935-724-7577	18	11	5950-836-0369	28	16
5935-724-7578	18	16	5950-892-8329	31	15
5935-724-7579	18	10	5950-921-3420	22	17
5935-724-7580	18	14	5950-921-4074	9	10
5935-724-7581	36	9	5955-882-8346	21	19
5935-724-7584	18	8	5961-022-5670	6	21
5935-724-7592	36	3	5961-022-5670	32	24
5935-725-4484	3	74	5961-054-0339	4	11
5935-725-4493	3	71	5961-054-0339	5	14
5935-726-6487	36	1	5961-054-0339	6	14
5935-761-3885	18	7	5961-054-0339	8	9
5935-762-0312	3	2	5961-054-0339	10	7
5935-762-0312	20	3	5961-054-0339	11	6
5935-765-5991	18	4	5961-054-0339	21	8
5935-784-5912	3	70	5961-054-0339	23	15
5935-784-5968	3	69	5961-054-0339	24	16
5935-786-7416	20	26	5961-054-0339	25	17
5935-823-0639	6	17	5961-054-0339	26	13
5935-838-3695	17	3	5961-054-0339	27	16
5935-843-7133	18	5	5961-054-0339	28	10
5935-880-4225	20	24	5961-054-0339	29	14
5935-880-8896	17	4	5961-054-0339	30	14
5935-902-1817	36	7	5961-054-0339	31	11
5935-959-4929	21	7	5961-054-0339	34	10
5940-050-2308	35	2	5961-058-8952	25	18
5940-082-5002	5	41	5961-059-2904	6	8
5940-419-9742	3	47	5961-069-2469	15	5
5940419-9742	20	44	5961-085-0468	16	3
5940-682-2477	3	24	5961-085-0468	35	7
5940-725-9498	34	29	5961-087-6047	25	14
5940-820-4549	17	6	5961-087-6047	26	8
5940-905-4576	3	6	5961-087-6047	32	14
5940-905-4576	15	4	5961-104-9898	5	24
5940-905-4576	17	8	5961-115-9923	35	5
5940-905-4576	20	49	5961-117-6092	22	30
5940-905-4576	35	1	5961-226-8579	6	19
5943-983-6055	20	38	5961-226-8579	23	25
5940-983-6059	3	53	5961-226-8579	24	27
5945-068-3927	3	7	5961-226-8579	25	28
5945-068-3927	20	22	5961-226-8579	29	25
5945-406-3076	8	16	5961-226-8579	30	22
5945-406-3076	10	9	5961-226-8579	31	18
5945-478-7662	8	15	5961-252-1577	28	20
5945-478-7662	33	9	5961-431-3246	29	26
5945-490-5199	3	9	5961-476-6203	5	15

SECTION IV NATION STOCK NUMBER AND PART NUMBER INDEX (CONTINUED)

STOCK NUMBER	FIG NO.	ITEM NO.	STOCK NUMBER	FIG NO	ITEM NO
5961-572-4284	27	24	5961-846-9157	26	11
5961-723-3602	3	8	5961-846-9157	27	11
5961-734-4405	7	8	5961-846-9157	28	8
5961-734-1105	28	11	5961-846-9157	29	12
5961-734-1105	31	10	5961-852-7549	6	9
5961-752-6121	10	6	5961-852-7549	26	9
5961-752-6121	11	4	5961-879-2474	6	12
5961-752-6121	21	5	5961-879-3091	30	11
5961-752-6121	24	14	5961-890-9867	25	26
5961-752-6121	25	15	5961-890-9867	26	20
5961-752-6121	26	10	5961-892-0889	6	11
5961-752-6121	29	11	5961-894-0684	8	6
5961-752-6121	30	9	5961-909-4138	30	13
5961-752-6121	31	8	5961-913-1747	4	17
5961-752-6121	32	15		7	13
5961-761-4504	9	14	5961-913-1747	11	9
5961-761-4504	12	10	5961-913-1747	23	26
5961-762-0201	3	66	5961-913-1747	24	26
5961-762-0201	4	6	5961-913-1747	26	21
5961-762-0201	34	6	5961-913-1747	27	25
5961-767-1522	16	1	5961-913-1747	34	17
5961-767-1522	35	3	5961-919-4224	8	10
5961-799-5539	5	12	5961-919-4224	12	7
5961-799-5539	6	15	5961-919-4224	26	12
5961-821-2309	9	7	5961-919-4224	29	13
5961-821-2309	24	10	5961-919-4224	32	16
5961-821-2309	27	12	5961-919-4224	33	7
5961-821-2309	29	9	5961-923-3940	4	9
5961-836-0382	30	8	5961-923-3940	5	11
5961-836-0382	31	7	5961-923-3940	24	15
5961-836-6667	4	7	5961-923-3940	34	9
5961-836-6667	5	9	5961-923-3951	5	23
5961-836-6667	7	5	5961-923-3951	15	6
5961-836-6667	24	13	5961-923-3951	35	6
5961-836-6667	34	7	5961-925-3777	5	21
5961-842-9864	4	8	5961-925-3777	6	18
5961-842-9864	5	10	5961-925-3777	9	13
5961-842-9864	6	10	5961-925-3777	25	29
5961-842-9864	7	6	5961-925-3777	28	19
5961-842-9864	8	8		29	27
5961-842-9864	9	8	5961-925-3777	32	23
5961-842-9864	12	6	5961-925-3777	33	12
5961-842-9864	22	10	5961-949-1432	30	23
5961-842-9864	23	12	5961-949-1432	31	19
5961-842-9864	24	11	5961-949-1432	33	14
5961-842-9864	25	13	5961-949-1440	33	15
5961-842-9864	27	14	5961-949-6563	11	10
5961-842-9864	28	9	5961-946-6563	26	19
5961-842-9864	29	8	5961-949-6563	27	26
5961-842-9864	30	10	5961-949-6563	28	21
5961-842-9864	31	9	5961-949-6563	29	24
5961-842-9864	32	13	5961-949-6563	31	17
5961-842-9864	33	6	5961-950-9887	8	7
5961-842-9864	34	8	5961-950-9887	23	13
5961-849-9157	10	5	5961-950-9887	24	12
5961-846-9157	11	5	5961-950-9887	28	7
5961-846-9157	21	4	5961-951-5474	8	11
5961-846-9157	23	14	5961-951-5474	10	8
5961-846-9157	25	12	5961-951-5474	26	14

SECTION IV NATIONAL STOCK NUMBER AND PART NUMBER INDEX (CONTINUED)

STOCK NUMBER	FIG NO.	ITEM NO.	STOCK NUMBER	FIG. NO.	ITEM NO.
5961-951-5474	33	8	5962-470-4303	28	40
5961-951-8757	4	18	5999-484-5513	4	10
5961-951-8757	5	22	5999-484-5513	5	13
5961-951-8757	6	20	5999-484-5513	6	13
5961-951-8757	7	14	5999-484-5513	9	9
5961-951-8757	8	18	5999-484-5513	11	7
5961-951-8757	9	12	5999-484-5513	21	6
5961-951-8757	12	9	5999-484-5513	22	11
5961-951-8757	21	10	5999-484-5513	23	16
5961-951-8757	22	19	5999-484-5513	24	17
5961-951-8757	23	24	5999-484-5513	25	16
5961-951-8757	24	25	5999-484-5513	27	15
5961-951-8757	25	27	5999-484-5513	30	12
5961-951-8757	26	22	5999-484-5513	34	11
5961-951-8757	27	23	6110-488-5307	3	36
5961-951-8757	28	18	6110-489-0041	20	7
5961-951-8757	29	23	6110-489-0410	3	30
5961-951-8757	30	21	6130-433-2345	3	12
5961-951-8757	32	22	6130-433-2346	20	21
5961-951-8757	33	13	6130-480-1244	3	13
5961-951-8757	34	18	6130-493-9265	3	15
5961-957-6865	3	28	6210-482-3870	3	45
5961-957-6865	5	8	6210-482-3871	3	42
5961-957-6865	7	4	6240-155-7836	3	41
5961-995-2310	7	7	6625-196-2844	18	3
5961-995-2310	24	9	6625-196-2845	20	20
5961-995-2310	27	13	6625-197-6384	3	21
5961-995-2310	29	10	6625-242-5796	18	21
5962-117-6075	22	29	6625-242-5797	36	8
5962-117-6075	28	39	6625-403-1082	3	22
5962-148-2858	4	28	6625-403-1083	3	23
5962-158-2858	5	40	6625-48-5053	2	2
5962-148-2858	6	37	6625-408-5055	3	14
5962-148-2858	8	33	6625-409-0932	20	19
5962-148-2858	11	28	6625-409-0995	3	20
5962-148-2858	23	49	6625-409-8158	19	2
5962-148-2858	24	45	6625-409-8160	3	17
5962-148-2858	25	59	6625-409-8162	3	18
59602-148-2858	27	58	6625-409-8162	9	11
5962-148-2858	28	37	6625-409-9068	20	8
5962-148-2858	29	59	6625-459-3401	18	2
5962-148-2858	31	38	6625-463-3968	20	17
5962-148-2858	34	28	6625-463-3969	3	19
5962-232-3948	25	60	6625-463-3672	20	13
5962-245-1612	9	30	6625-463-3973	20	14
5962-245-1616	9	29	6625-463-3982	20	11
5962-245-5325	10	25	6625-463-3983	20	9
5962-425-5325	26	45	6625-463-3986	20	10
5962-245-5325	30	54	6625-463-3988	20	15
5962-247-3392	9	28	6625-463-3989	20	12
5962-247-3392	12	24	6625-463-3991	20	18
5962-248-2336	11	26	6625-463-3993	20	16
5962-248-2336	21	20	6625-470-4315	18	6
5962-248-2336	24	46	6625-480-7641	2	1
5962-248-2336	26	44	6625-489-0435	19	1
5962-248-2336	29	58	6625-489-0462	18	18
5962-248-2336	30	55	6625-489-0467	36	5
5962-248-2336	31	37	6625-489-2669	18	9
5962-411-6306	11	27	6625-489-2670	18	15

SECTION IV NATIONAL STOCK NUMBER AND PART NUMBER INDEX (CONTINUED)

STOCK NUMBER	FIG NO.	ITEM NO.	STOCK NUMBER	FIG NO	ITEM NO
6625-489-2671	36	2			
6625-489-6102	18	12			
6625-489-6140	36	11			
6645-470-4305	3	75			

SECTION IV FEDERAL STOCK NUMBER AND PART NUMBER INDEX (CONTINUED)

PART NUMBER	FSCM	FIG NO.	ITEM NO.	PART NUMBER	FSCM	FIG NO.	ITEM NO.
A 1 0 0 6 7 D A P	07047	7	8	CM05ED510J03	81349	25	11
A10067DAP	07047	28	11	CM05ED510J03	81349	26	5
A10067DAP	07047	31	10	CM05ED510J03	81349	32	7
BBT0-3-62	05451	16	1	CM05FD101J03	81349	21	2
BBT0-3-6	05451	35	3	CM05FD121J03	81349	22	5
CH09A1NF474K	81349	6	7	CM05FD151J03	81349	10	4
CH05BX100K	81349	9	4	CM05FD181J03	81349	8	5
CK05BX221K	81349	9	5	CM05FD201J03	81349	31	4
CK05BX330K	81349	22	9	CU05FD221J03	81349	4	3
CK05BX471K	81349	9	6	CM05FD221J03	81349	11	3
CK06BX103K	81349	4	4	CM05FD221J03	81349	23	10
CK06BX103K	81349	6	5	CM05FD221J03	81349	24	8
CK06BX103K	81349	8	2	CM05FD221J03	81349	25	4
CK0BX103K	81349	10	2	CM05FD221J03	81349	26	3
CK06BX103K	81349	11	1	CM05FD221J03	81349	27	3
CK06BX103K	81349	23	9	CM05FD221J03	81349	28	3
CK06BX103K	81349	24	1	CM05FD221J03	81349	29	5
CK06BX103K	81349	25	5	CM05FD221J03	81349	32	9
CK06BX103K	81349	26	2	CM05FD221J03	81349	34	3
CK06BX103K	81349	27	1	CM05FD331J03	81349	32	1
CK06BX103K	81349	28	1	CM05FD391J03	81349	6	1
CK06BX103K	81349	29	1	CM05FD391J03	81349	26	7
CK06BX103K	81349	30	1	CM06FD102J03	81349	9	3
CK06BX103K	81349	31	2	CM06FD102J03	81349	12	4
CK06BX103K	81349	32	3	CM06FD102J03	81349	23	1
CK06BX103K	81349	33	1	CM06FD102J03	81394	24	4
CK06BX103K	81349	34	4	CM06FD102J03	81349	25	1
CK06BX104K	81349	5	1	CM06FD102J03	81349	26	4
CK06BX104K	81349	6	6	CM06FD102J03	81349	27	5
CK06BX104K	81349	32	4	CM06FD102J03	81349	30	6
CK06BX104K	81349	33	5	CM06FD102J03	81349	32	2
CK06BX105K	81349	6	2	CM06FD152J03	81349	22	4
CK06BX105K	81349	32	10	CM06FD222J03	81349	27	9
CK06BX105K	81349	33	4	CM06FD222J03	81349	30	4
CK06BX122K	81349	33	3	CM06FD27J03	81349	12	3
CK06BX472K	81349	8	4	CM06FD272J03	81394	30	7
CK06BX472P	81349	11	2	CM06FD332J03	81349	25	9
CK15BX104K	81349	4	1	CM06FD431J03	81349	22	3
CK15BX104K	81349	7	2	CM06FD472G03	81349	23	4
CK15BX104K	81349	7	1	CM06FD472G03	81349	24	7
CK15BX104K	81349	28	5	CM06FD472J03	81349	5	5
CK15BX104K	81349	31	6	CM06FD472J03	81349	23	8
CK15BX104K	81349	34	1	CM06FD472J03	81349	25	3
CK63AW103M	81349	7	3	CM06FD472J03	81349	27	2
CK63AW103M	81349	21	3	CM06FD472J03	81349	28	2
CL21BNO8OSPE	81349	4	5	CM06FD472J03	81349	29	4
CL21BNO8OSPE	81349	34	5	CM06FD472J03	81349	31	3
CL23BJ100TNE	81349	12	5	CM06FD511J03	81349	13	1
CL65DE150MP3	81349	15	1	CM06FD681J03	81349	32	8
CL65BE271MPE	81349	7	2	CM07FD103J03	81349	10	1
CL65BG101MPE	81349	5	3	CM07FD103J03	81349	27	7
CM05CD050D03	81349	9	1	CM07FD163J03	81349	27	10
CM05CD180J03	81349	30	3	CM07FD512J03	81349	26	6
CM05ED200J03	81394	31	5	CR37AU100KHZ	81349	21	19
CM05ED390J03	81349	25	7	CSR13B565KL	81349	22	7
CM05ED470J03	81349	5	4	CSR13B566KT	81349	28	4
CM05ED470J03	81349	6	4	CSR13B685KL	81349	25	8
CM05ED470J03	81349	10	3	CSR13C127KL	81349	23	6
CM05ED470J03	81349	30	5	CSR13C127KL	81349	25	6

SECTION IV FEDERAL STOCK NUMBER AND PART NUMBER INDEX (CONTINUED)

PART NUMBER	FSCM	FIG NO	ITEM NO	PART NUMBER	FSCM	FIG NO	ITEM NO
C S R 1 3 0 4 7 5 K L	81349	23	7	LP9A1A224J	01884	21	1
CSR13C475KL	81349	25	10	LP9A1A473J	01884	32	11
CSR13C475KL	81349	29	6	LP9A1C104J	01884	24	3
CSR13E125KL	81349	5	7	LP9A1C474J	01884	23	5
CSR13E156KL	81349	27	6	LP9A1C474J	01884	24	6
CSR13E156KL	81349	29	3	LP9A1C474J	01884	27	4
CSR13E396KL	81349	29	2	LP9A1E224J	01884	32	12
CSR13E476KL	81349	12	2	L22TE95P4X1	09922	20	25
CSR13E476KL	81349	22	2	L22TE95P4Y1	09922	3	73
CSR13E476KL	81349	24	2	L22TEI95S4N1	09922	3	72
CSR13F226KL	81349	6	3	L22TE95S4W1	09922	20	23
CSR13F226KL	81349	23	2	L22TF95P6N1	09922	18	17
CSR13F226KL	81349	32	5	L22TF95P6W1	09922	18	22
CSR13F226KL	81349	33	2	L22TF95P6W1	09922	36	10
CSR13F476KL	81349	12	1	L32TF95P6X1	09922	36	6
CSR13F476KL	81349	22	1	L22TF95S6N1	09922	18	19
CSR13F476KL	81349	23	3	L22TF95S6W1	09922	36	12
CSR13F476KL	81349	24	5	L22TF95S6X1	09922	36	4
CSR13F476KL	81349	27	8	L23TF95S6Y1	09922	18	20
CSR13F565KL	81349	22	6	MS25237-327	96906	3	41
CSR13F685KL	81349	5	6	MS3124E12-3P	96906	17	3
CSR13F685KL	81349	8	1	MS3124E14-12S	96906	3	74
CSR13F685KL	81349	25	2	MS3124E14-5P	96906	17	4
CSR13F685KL	81349	26	1	MS3124E20-41P	96906	20	26
CSR13G103ML	81349	22	8	MS3124E20-41s	96906	3	69
CSR13G10SKL	81349	8	3	MS3124E22-55P	96906	3	70
CSR13G105ML	81349	23	11	MS3124E22-55PZ	96906	3	71
CSR13G105ML	81349	28	6	MS3124E22-55SY	96906	20	24
CTM104VAJ	81349	9	2	MS3126F12-3S	96906	18	4
CU13CH331SP3	81349	4	2	MS3126F14-12P	96906	18	13
CU13CH331SP3	81349	34	2	MS3126F14-13s	96906	18	11
CU13CH47OSP3	81349	30	2	MS3126F14-5S	96906	18	7
CU13CH47OP3	81349	31	1	MS3126FTO-41P	96906	36	1
CW1108/AAM-35	80058	2	1	MS3126F20-41S	96906	36	3
CW1109/AAM-35	80058	19	1	MS3126F22-55P	96906	18	16
CX12408/U	80058	18	3	MS3126F22-55PW	96906	18	10
CX12409/U	80058	18	6	MS3126F22-55PY	96906	36	7
CX12432/AAM-35	80058	18	9	MS3126F22-55S	96906	18	14
CX12433/AAM-35	80058	18	12	MS3126F22-55SW	96906	36	9
CX12434/AAM-35	80058	18	15	MS3126F22-55SZ	96906	18	8
CX12435/AAM-35	80058	18	18	MS35059-21	96906	20	30
CX12436/AAM-35	80058	18	21	MS35059-23	96906	3	39
CX12437/AAM-35	80058	36	2	MS35059-23	96906	20	59
CX12438/AAM-35	80058	36	5	MS35059-26	96906	3	67
CX12439/AAM-35	80058	36	8	MS35059-29	96906	20	28
CX12440/AAM-35	80058	36	11	MS35431-3	96906	35	2
EA1AD055	35344	10	10	MS75052-5	96906	25	24
EA1D055	35344	26	17	MS75052-5	96906	32	20
EA1A124	35344	8	16	MS75052-5	96906	33	10
EA1A124	35344	10	9	MS75053-2	96906	31	15
EA1B131	35344	8	15	MS75054-5	96906	23	22
EA1B131	35344	33	9	MS75054-5	96906	24	23
GSE22-501-0013	24727	3	9	MS75054-5	96906	27	21
KC79-43	91836	3	37	MS75054-5	96906	29	21
KC79-43	91836	20	1	MS77068-1	96906	3	24
KJ2A006	35344	3	7	MS90537-23	96906	9	10
KJ2A006	35344	20	22	MS90537-49	96906	22	17
LP9A1A04J	01884	32	6	MS90542-6	96906	30	19
LP9A1A105J	01884	29	7	MS90542-15	96906	28	16

SECTION IV FEDERAL STOCK NUMBER AND PART NUMBER INDEX (CONTINUED)

PART NUMBER	FSCM	FIG NO.	ITEM NO.	PART NUMBER	FSCM	FIG NO.	ITEM NO.
MS91528-2D2B	96906	3	77	M39024-11-04	81349	31	12
MS91528-2D2B	96906	20	62	M39024-11-04	81349	32	19
MS91528-2M2B	96906	3	76	M39024-11-04	81349	34	12
MS91528-2M2B	96906	20	61	M39024-11-05	81349	22	16
MX8748/AAM-35	80058	2	2	M39024-11-05	81349	24	22
MX8749/AAM-35	80058	19	2	M39024-11-05	81349	29	19
M18312-02-0441	81349	17	9	M39024-11-03	81349	32	17
M 2 4 3 0 8 - 2 - 2	81349	3	31	M39024-11-06	81349	4	14
M24308-2-3	81349	3	5	M39024-11-06	81349	5	18
M24308-4-2	81349	16	2	M39024-11-06	81349	6	16
M24308-4-2	81349	35	4	M39024-11-06	81349	7	11
M24308-4-3	81349	15	2	M39024-11-06	81349	8	14
M39019-1-32	81349	3	49	M39024-11-06	81349	22	14
M39010-5-50	81349	3	44	M39024-11-06	81349	23	19
M39024-10-02	81349	3	3	M39024-11-06	81349	24	20
M39024-10-02	81349	20	2	M39024-11-06	81349	25	21
M39024-10-03	81349	3	2	M39024-11-06	81349	27	19
M39024-10-03	81349	20	3	M39024-11-06	81349	28	14
M39024-E-01	81349	22	12	M39024-11-06	81349	29	17
M39024-11-02	81349	4	13	M39024-11-06	81349	30	17
M39024-11-02	81349	5	17	M39024-11-06	81349	34	14
M39024-11-02	81349	7	10	M39024-11-07	81349	32	18
M39024-11-02	81349	8	13	M39024-11-08	81349	23	20
M39024-11-02	81349	10	12	M39024-11-08	81349	24	21
M39024-11-02	81349	22	13	M39024-11-08	81349	25	22
M39024-11-02	81349	23	18	M39024-11-08	81349	29	18
M39024-11-02	81349	24	19	P93717	56289	17	10
M39024-11-02	81349	25	20	RA20SASK103A	81349	20	57
M39024-11-02	81349	27	18	RA20SASK502A	81349	3	56
M79324-11-02	81349	28	13	RA20SASK502A	81349	20	58
M39024-11-02	81349	29	16	RBR55L10001QM	81349	25	46
M39024-11-02	81349	30	16	RBR55L11002QM	81349	25	55
M39024-11-02	81349	31	13	RBR55L12001QM	81349	25	47
M39024-11-02	81349	34	13	RBR55L32801QM	81349	25	48
M39024-11-03	81349	4	15	REPCSGF23ABR	97954	3	5
M39024-11-03	81349	5	19	REPCSGF23ACK	97954	3	50
M39024-11-03	81349	23	21	REPCSGF23ACL	97954	20	48
M39024-11-03	81349	25	23	REPCSGF23ACM	97954	3	46
M39024-11-03	81349	26	16	REPCSGF23ACN	97954	3	48
M39024-11-03	81349	27	20	REPCSGF23ACP	97954	3	51
M39024-11-03	81349	28	15	REPCSGF23ACS	97954	20	37
M39024-11-03	81349	29	20	REPCSGF23ACT	97954	20	33
M39024-11-03	81349	30	18	REPCSGF23ACV	97954	20	42
M39024-11-03	81349	31	14	REPCSGF23ACV	97954	20	41
M39024-11-03	81349	34	15	REPCSGF23ADE	97954	20	40
M39024-11-04	81349	4	12	REPCSGF23ADH	97954	20	45
M39024-11-04	81349	5	16	REPCSGF23ADJ	97954	20	43
M39024-11-04	81349	7	9	REPCSGF23ADK	97954	20	39
M39024-11-04	81349	8	12	REPCSGF23ADL	97954	3	59
M39024-11-04	81349	10	11	REPCSGF23ADM	97954	3	58
M39024-11-04	81349	22	15	REPCSGF23ADP	97954	20	34
M39024-11-04	81349	23	17	REPCSGF23ADR	97954	20	46
M39024-11-04	81349	24	18	REPCSGF23ADS	97954	20	35
M39024-11-04	81349	25	19	REPCSGF23ADT	97954	20	36
M39024-11-04	81349	26	15	REPCSGF23ADU	97954	3	60
M39024-11-04	81349	27	17	REPCSGF23AEF	97954	3	61
M39024-11-04	81349	28	12	REPCSGF23AEK	97954	3	62
M39024-11-04	81349	29	15	REPCSGF23AEJ	97954	3	57
M39024-11-04	81349	30	15	REPCSGF23AEK	97954	20	47

SECTION IV FEDERAL STOCK NUMBER AND PART NUMBER INDEX (CONTINUED)

PART NUMBER	FSCM	FIG. NO.	ITEM NO.	PART NUMBER	FSCM	FIG NO	ITEM NO
RE6OG16R2	81349	3	25	RN6OD1001F	81349	29	37
RE6CG3OR1	81349	3	26	RN6OD1001F	81349	30	36
RE7OG1212	81349	3	4	RN6OD1001F	81349	31	25
RE75G1302	81349	3	33	RN6OD1001F	81349	32	35
RE75G1872	81349	3	34	RN6OD1001F	81349	33	24
RE75G3322	81349	3	32	RN6OD1001F	81349	34	19
RE7568061	81349	3	35	RN6OD1002F	81349	4	20
RE77G2001	81349	20	5	RN6OD1002F	81349	5	31
RE77G4R64	81349	20	6	RN6OD1002F	81349	6	30
RE77G6R81	81349	20	4	RN6OD1002F	81349	7	17
RL32S24OJ	81349	8	20	RN6OD1002F	81349	9	26
RN55C1002F	81349	8	26	RN6OD1002F	81349	10	20
RN55C1212F	81349	8	22	RN6OD1002F	81349	11	21
RN55C1501F	81349	8	27	RN6OD1002F	81349	12	12
RN55C2001F	81349	8	23	RN6OD1002F	81349	13	4
RN55C3011F	81349	8	25	RN6OD1002F	81349	14	2
RN55C4321F	81349	8	29	RN6OD1002F	81349	15	7
RN55C4751F	81349	8	31	RN6OD1002F	81349	20	51
RN55C5621F	81349	8	30	RNBOD1002F	81349	21	14
RN6OC1002F	81349	23	39	RN6OD1002F	81349	22	25
RN6OC1002F	81349	29	48	RN6OD1002F	81349	23	29
RN6OC1003F	81349	25	34	RN6OD1002F	81349	24	30
RN6OC1213F	81349	27	46	RN6OD1002F	81349	25	38
RN6OC1622F	81349	25	56	RN6OD1002F	81349	26	29
RN6OC1961F	81349	4	27	RN6CD1002F	81349	27	42
RN6OC1961F	81349	34	27	RN6OD1002F	81349	29	29
RN6OC2611F	81349	4	25	RN6OD1002F	81349	30	29
RN6OC2611F	81349	34	25	RN6OD1002F	81349	31	28
RN6OC3922F	81349	23	36	RN6OD1002F	81349	32	29
RN6OC4220F	81349	29	56	RN6OD1002F	81349	33	19
RN6OC4641F	81349	25	57	RN6OD1002F	81349	34	20
RN6OC4751F	81349	6	35	RN6OD1002F	81349	35	8
RN6OC5112F	81349	25	51	RN6OD1002F	81349	5	15
RN6OC7871F	81349	29	57	RN6OD1003F	81349	12	23
RN6OC8251F	81349	24	39	RN6OD1003F	81349	22	23
RN6OC9091F	81349	29	46	RN6OD1003F	81349	27	56
RN6OD1OROF	81349	12	11	RN6OD1003F	81349	33	23
RN6OD1OROF	81349	27	21	RN6OD1004F	81349	23	48
RN6OD1000F	81349	9	18	RN6OD1004F	81349	25	35
RN6OD1000F	81349	11	15	RN6OD1004F	81349	27	33
RN6OD1000F	81349	12	19	RN6OD1004F	81349	28	31
RN6OD100CF	81349	26	26	RN6OD1100F	81349	31	35
RN6OD1000F	81349	28	28	RN6OD1102F	81349	27	57
RN6OD1000F	81349	30	27	RN6OD1103F	81349	11	17
RN6OD1001F	81349	4	19	RN6OD1182F	81349	32	30
RN6OD1001F	81349	5	26	RN6OD1210F	81349	26	42
RN6OD1001	81349	6	29	RN6OD1211F	81349	6	31
RN6OD1001F	81349	9	23	RN6OD1211F	81349	23	37
RN6OD1001F	81349	10	24	RN6OD1211F	81349	28	22
RN6OD1001F	81349	11	14	RN6OD1212F	81349	11	18
RN6OD1001F	81349	12	21	RN6OD1212F	81349	21	17
RN6OD1001F	81349	21	18	RN6OD1212F	81349	23	31
RN6OD1001F	81349	22	24	RN6OD1212F	81349	24	37
RN6OD1001F	81349	23	32	RN6OD1212F	81349	24	37
RN6OD1001F	81349	24	29	RN6OD1212F	81349	25	43
RN6OD1001F	81349	25	49	RN6OD1212F	81349	32	36
RN6OD1001F	81349	26	40	RN6OD1213F	81349	23	40
RN6OD1001F	81349	27	29	RN6OD1301F	81349	5	28
RN6OD1001F	81349	28	29	RN6OD1332F	81349	27	48
				RN6OD1472F	81349	29	44

SECTION IV FEDERAL STOCK NUMBER AND PART NUMBER INDEX (CONTINUED)

PART NUMBER	FSCM	FIG NO	ITEM NO	PART NUMBER	FSCM	FIG NO	ITEM NO
RN60D15ROF	81349	22	20	RN60D2001F	81349	34	22
RN60D15ROF	81349	23	38	RN60D2002F	81349	13	3
RN60D1500F	81349	5	38	RN60D2002F	81349	23	43
RN60D1500F	81349	29	50	RN60D2002F	81349	24	38
RN60D1501F	81349	4	24	RN60D2002F	81349	25	50
RN60D1501F	81349	5	27	RNBOD2002F	81349	27	55
RN60D1501F	81349	6	28	RN60D2002F	81349	29	34
RN60D1501F	81349	9	24	RN60D22RIF	81349	10	18
RN60D1501F	81349	11	24	RN60D22RIF	81349	32	37
RN60D1501F	81349	23	30	RN60D22RIF	81349	33	22
RN60D1501F	81349	24	42	RN60D2210F	81349	4	21
RN60D1501F	81349	25	32	RN60D2210F	81349	10	23
RN60D1501F	81349	27	35	RNBOD2210F	81349	24	28
RN60D15101F	81349	28	26	RN60D2210F	81349	25	45
RN60D1501F	81349	29	33	RN60D2210F	81349	27	40
RN60D1501F	81349	31	27	RN60D2210F	81349	29	38
RN60D1501F	81349	32	31	RN60D2210F	81349	34	21
RN60D1501F	81349	33	21	RN60D2211F	81349	26	24
RN60D1501F	81349	34	24	RNBOD2211F	81349	27	41
RN60D1502F	81349	26	39	RN60D2211F	81349	29	41
RN60D1502F	81349	27	39	RN60D3211F	81349	32	28
RN60D1502F	81349	29	52	RN6CD2211F	81349	33	18
RN60D1502F	81349	32	34	RN60D2212F	81349	27	52
RN60D1503F	81349	30	48	RN60D2212F	81349	30	50
RN60D1621F	81349	5	32	RNBOD2212F	81349	32	40
RN60D1621F	81349	26	25	RN60D2213F	81349	27	50
RN60D1621F	81349	30	30	RN60D243CF	81349	27	36
RN60D1622F	81349	22	27	RN60D2432F	81349	29	40
RN60D1820F	81349	30	32	RN60D2490F	81349	31	29
RN60D1821F	81349	30	52	RNGOD2491F	81349	25	36
RN60D1822F	81349	11	22	RN60D2441F	81349	29	36
RN60D1822F	81349	23	46	RN6CD2491F	81349	30	41
RN60D1822F	81349	29	54	RN60D24W.F	81349	9	22
RN60D1822F	81349	30	44	RNBOD274CF	81349	23	42
RN60D2000F	81349	10	14	RN60D2740F	81349	25	40
RN60D2000F	81349	11	13	RN60D2740F	81349	28	33
RN60D2000F	81349	24	41	RN60D2741F	81349	5	33
RN60D2000F	81349	25	54	RNFJOD2741F	81349	13	6
RN60D2000F	81349	26	31	RN60D2741F	81349	26	38
RN60D2000F	81349	27	31	RN60D3742F	81349	6	33
RN60D2000F	81349	28	27	RNBOD2742F	81349	11	12
RN60D2000F	81349	29	35	RN60D2742F	81349	27	43
EW60D2000F	81349	30	39	RNBOZI3010F	81349	26	32
RN60D2000F	81349	31	22	RN60D3010F	81349	29	49
RN60D2001F	81349	4	22	RN60D3011F	81349	5	34
RN60D2001F	81349	5	30	RN60D3011F	81349	12	15
RN60D2001F	81349	6	23	RN6CD3011F	81349	26	30
RN60D2001F	81349	10	21	RN60D3011F	81349	27	47
RN60D2001F	81349	11	20	RNBOD3012F	81349	9	25
RN60D2001F	81349	12	18	RN60D3012F	81349	10	19
RN60D2001F	81349	23	47	RNBOD3012F	81349	27	44
RN60D2001F	81349	24	31	FtN60D3242F	81349	25	42
RN60D2001F	81349	25	37	RN60D332CF	81349	21	11
RN60D2001F	81349	26	35	RN6CD3320F	81349	25	33
RN60D2001F	81349	27	27	RN6CD3320F	81349	28	32
RN60D2001F	81349	28	36	RMXID3322F	81349	27	30
RN60D2001F	81349	29	45	FNBOD3321F	81349	30	46
RN60D2001F	81349	30	34	RW60D332W	81349	32	33
RN60D2001F	81349	31	36	RN6rn332Z	81349	6	27
RN60D2001F	81349	32	27	RN60D3322F	81349	11	25

SECTION IV FEDERAL STOCK NUMBER AND PART NUMBER INDEX (CONTINUED)

PART NUMBER	FSCM	FIG. NO.	ITEM NO	PART NUMBER	FSCM	FIG NO	ITEM NO
RN60D3322F	81349	12	20	RN60D51R1F	81349	32	25
RN60D3322F	81349	24	33	RN60D51R1F	81349	33	17
RN60D3322F	81349	27	45	RN60D5111F	81349	13	5
RN60D3322F	81349	30	45	RN60D5111F	81349	26	28
RN60D3322F	81349	32	26	RN60D5112F	81349	9	19
RN60D3651F	81349	30	37	RN60D5112F	81349	25	30
RN60D3651F	81349	31	26	RN60D5231F	81349	10	17
RN60D3652F	81349	27	49	RN60D5620F	81349	30	53
RN60D3652F	81349	31	30	RN60D5622F	81349	30	49
RN60D39R2F	81349	26	37	RN60D6190F	81349	9	21
RN60D39R2F	81349	33	25	RN60D6190F	81349	29	39
RN60D3920F	81349	9	17	RN60D6151F	81349	7	16
RN60D3920F	81349	26	33	FN60D6191F	81349	12	22
RN60D3921F	81349	23	44	RN60D4191F	81349	31	24
RN60D3921F	81349	29	32	RN60D6192F	81349	21	13
RN60D3922F	81349	12	16	RN60D68R1F	81349	12	13
RN60D3922F	81349	29	51	RN60D6810F	81349	25	41
RN60D3922F	81349	31	31	RN60D6811F	81349	27	53
RN60D3923F	81349	6	25	RN60D6812F	81349	27	38
RN60D3923F	81349	25	58	RN60D6813F	81349	23	33
RN60D4221F	81349	11	19	RN60D75ROF	81349	26	34
RN60D4320F	81349	23	34	RN60D7500F	81349	10	22
RN60D4321F	81349	30	51	RN60D7500F	81349	26	41
RN60D4322F	81349	6	26	RN60D7501F	81349	29	43
RN60D4423F	81349	11	11	RN60D7501F	81349	30	35
RN60D4750F	81349	10	15	RN60D7503F	81349	6	24
RN60D4750F	81349	11	16	RN60D82R5F	81349	30	24
RN60D4750F	81349	30	33	RN60D82R5F	81349	31	20
RN60D4750F	81349	31	33	RN60D8250F	81349	25	44
RN60D4750F	81349	33	20	RN60D8251F	81349	21	15
RN60D4751F	81349	6	32	RN60D8251F	81349	30	43
RN60D4751F	81349	12	14	RN60D8252F	81349	23	45
RN60D4751F	81349	22	22	RN60DB252F	81349	25	53
RN60D4751F	81349	27	34	RN60D8252F	81349	29	55
RN60D4751F	81349	29	30	RN60D8252F	81349	30	47
RN60D4751F	81349	32	39	RN60D9090F	81349	21	12
RN60D4751F	81349	28	35	RN60D9091F	81349	11	23
RN60D4752F	81349	6	36	RN60D9091F	81349	24	44
RN60D4752F	81349	21	16	RN60D9091F	81349	28	34
RN60D4752F	81349	22	28	RN60D9091F	81349	30	26
RN6CD4752F	81349	23	28	RN60E1002F	81349	28	25
RN60D4752F	81349	24	35	RN60E1332F	81349	28	24
RN60D4752F	81349	27	51	RN65C1004F	81349	17	1
RH60D4752F	81349	31	32	RN65C1331F	81349	5	37
RN60D4990F	81349	12	17	RN65C1473F	81349	8	24
RN60D4990F	81349	20	50	RN65C2871F	81349	5	36
RN60D4990F	81349	26	36	RN65C3830F	81349	8	21
RN60D4991F	81349	23	41	RN650250F	81349	7	21
RN60D4991F	81349	24	32	RN65D10ROF	81349	33	16
RN60D4991F	81349	27	54	RN65D1300F	81349	3	65
RN60D4991F	81349	29	47	RN65D2000F	81349	30	25
RN60D51R1F	81349	7	18	RN65D4320F	81349	31	21
RN60D51R1F	81349	10	16	RN65D4750F	81349	32	38
RN60D51R1F	81349	23	27	RN65D5110F	81349	30	40
RN60D51R1F	81349	24	36	RN65F2430F	81349	8	19
RN60D51R1F	81349	25	31	RN65F2493F	81349	8	32
RN60D51R1F	81349	26	23	RN65F51R1F	81349	20	52
RN60D51R1F	81349	27	37	RN75B5620F	81349	30	38
RN60D51R1F	81349	29	28	RT11C2P101	81349	9	27
RN60D51R1F	81349	31	34	RT11C2P502	81349	9	20

SECTION IV FEDERAL STOCK NUMBER AND PART NUMBER INDEX (CONTINUED)

PART NUMBER	FSCM	FIG. NO.	ITEM NO	PART NUMBER	FSCM	FIG NO	ITEM NO
RT22C2P103	81349	30	28	SN52709L	01295	29	59
RT22C2P103	81349	31	23	SN52709L	01295	31	38
RT22C2P201	81349	7	20	SN52709L	01295	34	23
RT22C2P201	81349	30	31	SN52710L	01295	11	26
RT22C2P202	81349	30	42	SN52710L	01295	21	20
RT22C2P502	81349	8	28	SN62710L	01295	24	46
RT24C2P102	81349	5	35	SN52710L	01295	26	44
RT24C2P102	81349	24	43	SN52710L	01295	29	58
RT24C2P102	81349	27	28	SN52710L	01295	30	55
RT24C2P103	81349	22	26	SN52710L	01295	31	37
RT24C2P103	81349	23	35	SN52711L	01295	25	60
RT24C2P103	81349	24	34	SN5400-5	01295	11	27
RT24C2P103	81349	25	52	SN5410J	01295	9	30
RT24C2P103	81349	27	32	SN5430-1	01295	22	30
RT24C2P103	81349	28	30	SN5440J	01295	9	28
RT24C2P103	81349	29	42	SN5440J	01295	12	24
RT24C2P103	81349	32	32	SN5440-1	01295	28	40
RT24C2P201	81349	25	39	SN5473J	01295	9	29
RT24C2P202	81349	6	34	SN5473-1	01295	22	29
RT24C2P202	81349	29	31	SN5473-1	01295	28	39
RT24C2P501	81349	4	26	UPCCSGM23AABR	97954	8	17
RT24C2P501	81349	34	26	UPCCSGM23AACK	97954	6	17
RT24C2P502	81349	24	40	UPCCSGM23AAAL	97954	34	16
RT24C2P502	81349	26	27	UPCCSGM23AACM	97954	4	16
RT24C2P502	81349	28	23	UPCCSGM23AACN	97954	5	20
RT24C2W501	81349	26	43	UPCCSGM23AACP	97954	7	12
RV4SAYS503A	81349	20	56	UPCCSGM23AACS	97954	25	25
RW68VR33	81349	4	23	UPCCSGM23AACT	97954	24	24
RW68VR33	81349	34	23	UPCCSGM23AACU	97954	29	22
RW69VR47	81349	7	15	UPCCSGM23AACV	97954	28	17
RW69VR56	81349	7	19	UPCCSGM23AADE	97954	27	22
RW69VIR8	81349	5	29	UPCCSGM23AADH	97954	31	16
RW70U1R00F	81349	5	25	UPCCSGM23AADJ	97954	30	20
RW70U10R0F	81349	6	22	UPCCSGM23AADK	97954	26	18
RW70U2210F	81349	9	16	UPCCSGM23AADL	97954	11	8
RW78U4752F	81349	3	10	UPCCSGM23AADM	97954	10	13
RW78U7682F	81349	3	16	UPCCSGM23AADM	97954	12	8
RW78U8872F	81349	3	11	UPCCSGM23AADP	97954	23	23
RW81U1210F	81349	5	39	UPCCSGM23AADR	97954	32	21
SE12XC07	81349	34	29	UPCCSGM23AADS	97954	22	18
SE16XC01	81349	5	41	UPCCSGM23AAD7	97954	21	9
SE209D01	81349	3	6	UPCCSGM23AAEF	97954	13	2
SE209D01	81349	15	4	UPCCSGM23AAEH	97954	14	1
SE209D01	81349	17	8	UPCCSGM23AAEJ	97954	9	11
SE209D01	81349	20	49	UPCCSGM23AAEK	97954	33	11
SE209D01	81349	35	1	UP106M	80058	18	5
SK416-4	24434	15	3	08-83283-81	87034	3	45
SN52702L	01295	10	25	08-83283-82	87034	3	43
SN52702L	01295	26	45	08-83283-83	87034	3	42
SN52702L	01295	30	54	1N3022B	81349	30	8
SN52709L	01295	4	28	1N3022B	81349	31	7
SN52709L	01295	5	40	1N3028B	81349	6	12
SN52709L	01295	6	37	1N3611	81349	3	28
SN52709L	01295	8	33	1N3611	81349	5	8
SN52709L	01295	11	28	1N3611	81349	7	4
SN52709L	01295	23	49	1N3612	81349	3	8
SN52709L	01295	24	45	1N3613	81349	6	8
SN52709L	01295	25	59	1N5550	81349	3	66
SN52709L	01295	27	58	1N5550	81349	4	6
SN52709L	01295	28	37	1N5550	81349	34	6

SECTION IV FEDERAL STOCK NUMBER AND PART NUMBER INDEX (CONTINUED)

PART NUMBER	FSCM	FIG. NO.	ITEM NO	PART NUMBER	FSCM	FIG NO	ITEM NO
1N645	81349	25	14	1N914	81349	29	8
1N645	81349	26	8	1N914	81349	30	10
1N645	81349	32	14	1N914	81349	31	9
1N751A	81349	9	7	1N914	81349	32	13
1N751A	81349	24	10	1N914	81349	33	6
1N751A	81349	27	12	1N914	81349	34	8
1N751A	81349	29	9	1N938B	81349	6	11
1N752A	81349	7	7	10105DAP	07047	8	11
1N752A	81349	24	9	10105DAP	07047	10	8
1N752A	81349	27	13	10105DAP	07047	26	14
1N752A	81349	29	10	10105DAP	07047	33	8
1N753A	81349	10	6	10162DAP	07047	30	13
1N753A	81349	11	4	19-1963-1	91812	3	40
1N753A	81349	21	5	2N1724	81349	15	5
1N753A	81349	24	14	2N2151	81349	5	23
1N753A	81349	25	15	2N2151	81349	15	6
1N753A	81349	26	10	2N2151	81349	35	6
1N753A	81349	29	11	2N2219	81349	30	23
1N753A	81349	30	9	2N2219A	81349	31	19
1N753A	81349	31	8	2N2219A	81349	33	14
1N753A	81349	32	15	2N2222A	81349	4	18
1N754A	81349	6	9	2N2222A	81349	5	22
1N754A	81349	26	9	2N2222A	81349	6	20
1N755A	81349	30	11	2N2222A	81349	7	14
1N758A	81349	8	6	2N2222A	81349	8	18
1N759A	81349	10	5	2N2222A	81349	9	12
1N759A	81349	11	5	2N2222A	81349	12	9
1N759A	81349	21	4	2N2222A	81349	21	10
1N759A	81349	23	14	2N2222A	81349	22	19
1N759A	81349	25	12	2N2222A	81349	23	24
1N759A	81349	26	11	2N2222A	81349	24	25
1N759A	81349	27	11	2N2222A	81349	25	27
1N759A	81349	28	8	2N2222A	81349	26	22
1N759A	81349	29	12	2N2222A	81349	27	23
1N816	81349	4	7	2N2222A	81349	28	18
1N816	81349	5	9	2N2222A	81349	29	23
1N816	81349	7	5	2N2222A	81349	30	21
1N816	81349	24	13	2N2222A	81349	32	22
1N816	81349	34	7	2N2222A	81349	33	13
1N825	81349	4	9	2N2222A	81349	34	18
1N825	81349	5	11	2N2432	81349	11	10
1N825	81349	24	15	2N2432	81349	26	19
1N825	81349	34	9	2N2432	81349	27	26
1N827	81349	8	7	2N2432	81349	28	21
1N827	81349	23	13	2N2432	81349	29	24
1N827	81349	24	12	2N2432	81349	31	17
1N827	81349	28	7	2N2905A	81349	33	15
1N914	81349	4	8	2N2907	81349	4	17
1N914	81349	5	10	2N2907	81349	7	13
1N914	81349	6	10	2N2907	81349	11	9
1N914	81349	7	6	2N2907	81349	23	26
1N914	81349	8	8	2N2907	81349	24	26
1N914	81349	9	8	2N2907	81349	26	27
1N914	81349	12	6	2N2907	81349	27	25
1N914	81349	22	10	2N2907	81349	34	17
1N914	81349	23	12	2N2907A	81349	5	21
1N914	81349	24	11	2N2907A	81349	6	18
1N914	81349	25	13	2N2907	81349	9	13
1N914	81349	27	14	2N2907A	81349	25	29
1N914	81349	28	9	2N2907A	81349	28	19

SECTION IV FEDERAL STOCK NUMBER AND PART NUMBER INDEX (CONTINUED)

PART NUMBER	FSCM	FIG NO.	ITEM NO.	PART NUMBER	FSCM	FIG NO.	ITEM NO.
2N2907A	81349	29	27	692415-1	96214	20	20
2N2907A	81349	32	23	692463-1	96214	20	8
2N2907A	81349	33	12	692466-1	96214	3	20
2N2946A	81349	28	20	692469-1	96214	3	14
2N3439	81349	6	21	692472-1	96214	20	19
2N3439	81349	32	24	692580-1	96214	1	2
2N3506	81349	5	24	692581-1	96214	1	1
2N3821	81349	29	26	692583-1	96214	3	78
2N3846	81349	35	5	692597-1	96214	2	3
2N3902	81349	16	3	692613-1	96214	20	63
2N3902	81349	35	7	692614-1	96214	19	3
2N3980	81349	27	24	694753-2	96214	3	1
2N4856	81349	25	26	695916-1	96214	3	30
2N4856	81349	26	20	715384-1	96214	17	2
2N4949	81349	9	14	715393-1	96214	17	12
2N4949	81349	12	10	725081-1	96214	3	12
2N930	81349	6	19	725084-1	96214	3	13
2N930	81349	23	25	725087-1	96214	3	15
2N930	81349	24	27	725090-1	96214	3	19
2N930	81349	25	28	725096-1	96214	20	9
2N930	81349	29	25	725099-1	96214	20	10
2N930	81349	30	22	725102-1	96214	20	11
2N930	81349	31	18	725105-1	96214	20	12
2051-2	71279	17	6	725108-1	96214	20	13
2209-4A	13103	5	12	725111-1	96214	20	14
2209-4A	13103	6	15	725114-1	96214	20	15
33-106	72653	18	1	725117-1	96214	20	16
33-108	72653	18	2	725120-1	96214	20	17
37TB14	81349	20	38	725123-1	96214	20	18
37TB18	81349	3	53	725126-1	96214	20	21
418633-63	96214	20	32	7717-18N	13103	4	10
418633-66	96214	3	68	7717-18N	13103	5	13
418633-67	96214	3	64	7717-18N	13103	6	13
418633-67	96214	20	53	7717-18N	13103	9	9
418633-68	96214	3	35	7717-18N	13103	11	7
418633-69	96214	3	63	7717-18N	13103	21	6
418633-70	96214	3	54	7717-18N	13103	22	11
418633-70	96214	20	60	7717-18N	13103	23	16
418633-71	96214	3	52	7717-18N	13103	24	17
418633-71	96214	20	27	7717-18N	13103	25	16
418633-73	96214	20	29	7717-18N	13103	27	15
418633-72	96214	20	54	7717-18N	13103	30	12
418633-74	96214	20	55	7717-18N	13103	34	11
418633-75	96214	20	31	7717-19DAP	13103	4	11
5JX94	56289	17	7	7717-19DAP	13103	5	14
519659-1	96214	3	75	7717-19DAP	13103	6	14
530537-41	96214	3	27	7717-19DAP	13103	8	9
532007-11	96214	29	53	7717-19DAP	13103	10	7
6111B1-10	13103	5	15	7717-19DAP	13103	11	6
636229-1	96214	3	29	7717-19DAP	13103	21	8
692083-1	96214	17	11	7717-19DAP	13103	23	15
692233-1	96214	3	36	7717-19DAP	13103	24	16
692235-1	96214	20	7	7717-19DAP	13103	25	17
692287-2	96214	3	47	7717-19DAP	13103	26	13
692287-2	96214	20	44	7717-19DAP	13103	27	16
692367-1	96214	3	17	7717-19DAP	13103	28	10
692400-1	96214	3	21	7717-19DAP	13103	29	14
692406-1	96214	3	22	7717-19DAP	13103	30	14
692409-1	96214	3	23	7717-19DAP	13103	31	11
692412-1	96214	3	18	7717-19DAP	13103	34	10

SECTION IV FEDERAL STOCK NUMBER AND PART NUMBER INDEX (CONTINUED)

PART NUMBER	FSCM	FIG. NO	ITEM NO
7717-21DAP	13103	25	18
7717-44N	13103	8	10
7717-44N	13103	12	7
7717-44N	13103	26	12
7717-44N	13103	29	13
7717-44N	13103	32	16
7717-44N	13103	33	7
8000AG9	91506	21	7
811B12	73138	28	38
9013-000-1002	72982	17	5

By Order of the Secretary of the Army:

FRED C. WEYAND
General, United States Army
Chief of Staff

Official.

PAUL T. SMITH
Major General United States Army
The Adjutant General

DISTRIBUTION:

**To be distributed in accordance with DA Form 12-36A, (qty rqr block no. 649)
Direct and General Support maintenance requirements for AN/AAM-35.**

*US GOVERNMENT PRINTING OFFICE 1976-603-770 191

END

03-17-83

DATE



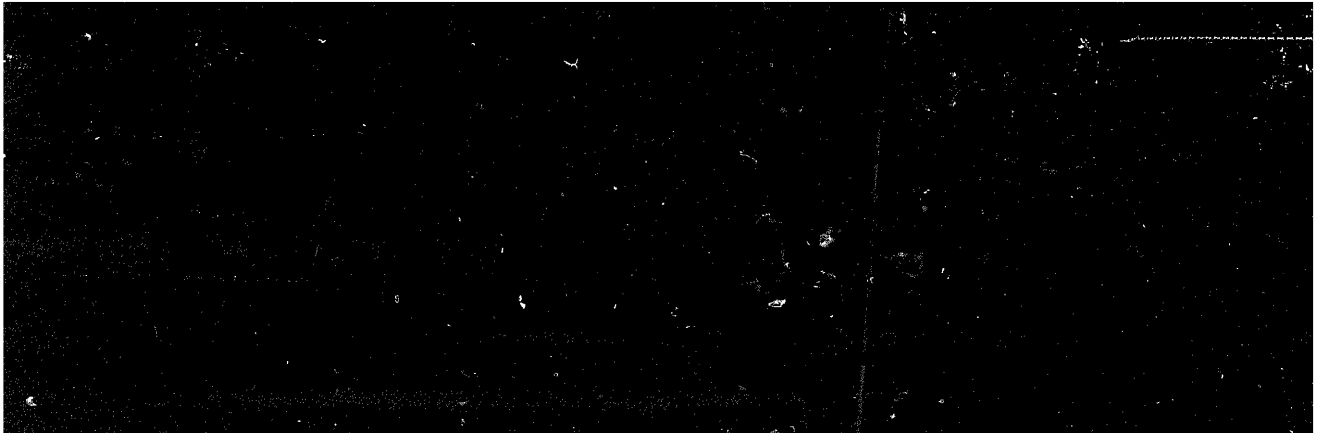

DEPARTMENT OF THE ARMY

MICROFORM
TEST TARGET

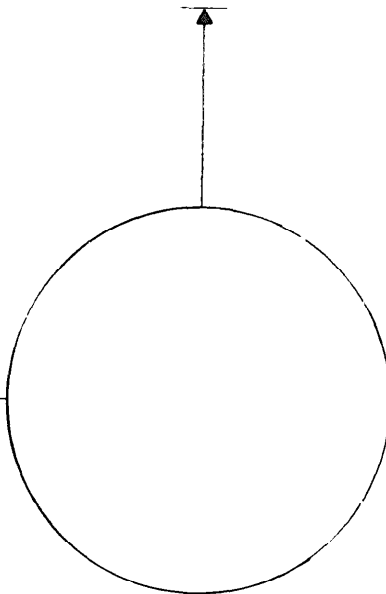
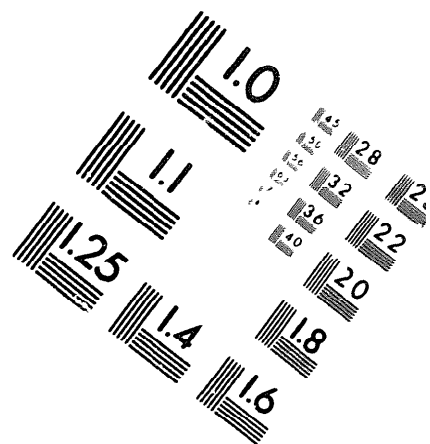
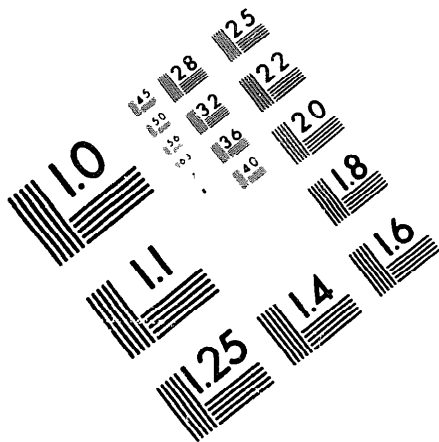

150 MM

1.0 mm (e= .81 mm)

ABCDEFGHIJKLMNQRSTUUVWXYZ1234567890
abcdefghijklmnopqrstuvwxyz\$¢£/%#½¼¾—=+x&@*

1.5 mm (e= 1.09 mm)

ABCDEFGHIJKLMNQRSTUUVWXYZ1234567890
abcdefghijklmnopqrstuvwxyz\$¢£/%#½¼¾—=+x&@*

2.0 mm (e= 1.37 mm)

ABCDEFGHIJKLMNQRSTUUVWXYZ
abcdefghijklmnopqrstuvwxyz
1234567890\$¢£/%#½¼¾—=+x&@*

2.5 mm (e= 1.77 mm)

ABCDEFGHIJKLMNQRSTUUVWXYZ
abcdefghijklmnopqrstuvwxyz
1234567890\$¢£/%#½¼¾—=+x&@*

1.0 mm (e= .81 mm)

ABCDEFGHIJKLMNQRSTUUVWXYZ1234567890
abcdefghijklmnopqrstuvwxyz\$¢£/%#½¼¾—=+x&@*

1.5 mm (e= 1.09 mm)

ABCDEFGHIJKLMNQRSTUUVWXYZ1234567890
abcdefghijklmnopqrstuvwxyz\$¢£/%#½¼¾—=+x&@*

2.0 mm (e= 1.37 mm)

ABCDEFGHIJKLMNQRSTUUVWXYZ
abcdefghijklmnopqrstuvwxyz
1234567890\$¢£/%#½¼¾—=+x&@*

2.5 mm (e= 1.77 mm)

ABCDEFGHIJKLMNQRSTUUVWXYZ
abcdefghijklmnopqrstuvwxyz
1234567890\$¢£/%#½¼¾—=+x&@*

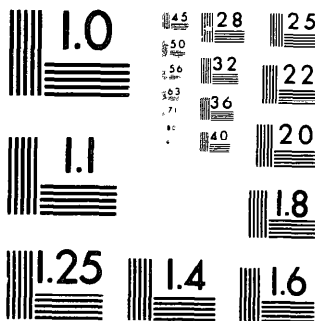

200 MM

250 MM

